

User's Guide

Designer Brilliance™ | 80

This household sewing machine is designed to comply with IEC/EN 60335-2-28 and UL1594.

IMPORTANT SAFETY INSTRUCTIONS

When using an electrical appliance, basic safety precautions should always be followed, including the following:

Read all instructions before using this household sewing machine. Keep the instructions at a suitable place close to the machine. Make sure to hand them over if the machine is given to a third party.

DANGER –TO REDUCE THE RISK OF ELECTRIC SHOCK:

- A sewing machine should never be left unattended when plugged in. The electrical socket, to which the machine is plugged in should be easily accessible. Always unplug this sewing machine from the electric outlet immediately after using and before cleaning, removing covers, lubricating or when making any other user servicing adjustments mentioned in the instruction manual.

WARNING –TO REDUCE THE RISK OF BURNS, FIRE, ELECTRIC SHOCK, OR INJURY TO PERSON:

- Do not allow to be used as a toy. Close attention is necessary when this sewing machine is used by or near children.
- Use this sewing machine only for its intended use as described in this manual. Use only attachments recommended by the manufacturer as contained in this manual.
- Never operate this sewing machine if it has a damaged cord or plug, if it is not working properly, if it has been dropped or damaged, or dropped into water. Return the sewing machine to the nearest authorized dealer or service center for examination, repair, electrical or mechanical adjustment.
- Never operate the sewing machine with any air openings blocked. Keep ventilation openings of the sewing machine and foot control free from the accumulation of lint, dust, and loose cloth.
- Keep fingers away from all moving parts. Special care is required around the sewing machine needle.
- Always use the proper needle plate. The wrong plate can cause the needle to break.
- Do not use bent needles.
- Do not pull or push fabric while stitching. It may deflect the needle causing it to break.
- Wear safety glasses.
- Switch the sewing machine off (“0”) when making any adjustment in the needle area, such as threading needle, changing needle, threading bobbin, or changing presser foot, etc.
- Never drop or insert any object into any opening.
- Do not use outdoors.
- Do not operate where aerosol (spray) products are being used or where oxygen is being administered.
- To disconnect, turn all controls to the off (“0”) position, then remove plug from outlet.
- Do not unplug by pulling on cord. To unplug, grasp the plug, not the cord.
- The foot control is used to operate the machine. Avoid placing other objects on the foot control.
- Do not use the machine if it is wet.

- If the LED lamp is damaged or broken, it must be replaced by the manufacturer or its service agent or a similarly qualified person, in order to avoid a hazard.
- If the cord connected with the foot control is damaged, it must be replaced by the manufacturer or its service agent or a similarly qualified person, in order to avoid a hazard.
- This sewing machine is provided with double insulation. Use only identical replacement parts. See instructions for Servicing of Double-Insulated Appliances.

SAVE THESE INSTRUCTIONS

FOR CENELEC COUNTRIES ONLY:

This appliance can be used by children aged from 8 years and above and persons with reduced physical, sensory or mental capabilities or lack of experience and knowledge if they have been given supervision or instruction concerning use of the appliance in a safe way and understand the hazards involved. Children shall not play with the appliance. Cleaning and user maintenance shall not be made by children without supervision.

The noise level under normal operating conditions is less than 80dB(A).

The machine must only be used with foot control of type FR5 manufactured by Shanghai Binao Precision Mould Co., Ltd.

FOR NON CENELEC COUNTRIES:

This sewing machine is not intended for use by persons (including children) with reduced physical, sensory or mental capabilities, or lack of experience and knowledge, unless they have been given supervision or instruction concerning use of the sewing machine by a person responsible for their safety. Children should be supervised to ensure that they do not play with the sewing machine.

The noise level under normal operating conditions is less than 80dB(A).

The machine must only be used with foot control of type FR5 manufactured by Shanghai Binao Precision Mould Co., Ltd.

SERVICING OF DOUBLE INSULATED PRODUCTS

In a double-insulated product, two systems of insulation are provided instead of grounding. No ground means is provided on a double-insulated product, nor should a means for grounding be added to the product. Servicing of a double-insulated product requires extreme care and knowledge of the system and should be done only by qualified service personnel. Replacement parts for a double-insulated product must be identical to those parts in the product. A double-insulated product is marked with the words 'DOUBLE INSULATION' or 'DOUBLE INSULATED'.

TABLE OF CONTENTS

I	Introduction	9		
	Machine Overview	10		
	Front	10		
	Needle Area	11		
	Rear	11		
	Accessory Tray	11		
	Embroidery Unit	11		
	Function Buttons	12		
	Speed	12		
	Needle Stop Up/Down	12		
	Cut Function	12		
	Reverse	12		
	Start/Stop	12		
	FIX function	12		
	STOP function	13		
	Presser Foot Down and Pivot	13		
	Presser Foot Up and Extra Lift	13		
	Basic Gestures for the Multi-Touch Screen	14		
	Accessories	15		
	Included Accessories	15		
	Included Hoops	15		
	Presser Feet	16		
	Stitch Overview	18		
	Utility Stitches	18		
	Stitch Menu Overview	21		
	Alphabets	21		
2	Preparations	23		
	Unpacking Machine and Embroidery Unit	24		
	Connect the Power Cord and Foot Control	24		
	Pack Away After Sewing	25		
	USB Port	25		
	Using a USB device	25		
	Getting Started with WiFi and <i>mySewnet</i> [™] Cloud	26		
	LED Lights	26		
	Free Arm	26		
	Manual Thread Cutter	26		
	Thread Sensor	27		
	Spool Pins	27		
	Horizontal Position	27		
	Vertical Position	28		
	Auxiliary Spool Pin	28		
	Threads	29		
	Needles	30		
	Important Needle Information	30		
	Changing the Needle	31		
	Threading the Upper Thread	31		
	Horizontal Spool Pin	31		
	Needle threader	32		
	Selecting Correct Thread/Needle Combination	33		
	Threading for Twin Needle	34		
	Bobbin Winding	35		
	Bobbin Winding through the needle	35		
	Winding Specialty Threads	36		
	Bobbin Winding while embroidering or sewing	36		
	Inserting the Bobbin	37		
	Changing the Presser Foot	37		
	Attaching the Sensor One-Step Buttonhole Foot	38		
	Attaching the Sensor Q-Foot	38		
	Dual Feed With Changeable Presser Feet	38		
	Changing to Straight Stitch Plate	40		
3	Embroidery Preparations	41		
	Embroidery Unit	42		
	Embroidery Hoop Overview	42		
	Sensor Q-Foot	42		
	Straight Stitch Plate	43		
	Designs	43		
	DESIGNER BRILLIANCE [™] 80 Sampler Book	43		
	Connect the Embroidery Unit	43		
	Remove the Embroidery Unit	44		
	To Hoop the Fabric	44		
	Slide on/off the Hoop	44		
4	The Multi-Touch Screen	45		
	Multi-Touch Screen	46		
	Gestures	46		
	Smart Toolbox	47		
	Common Functions	48		
	OK	48		
	Cancel	48		
	Embroidery Edit	48		
	Embroidery Stitch Out	48		
	Touch & Hold	48		
	Topbar	49		
	WiFi	49		
	<i>mySewnet</i> [™]	50		
	Wireless Firmware Update	50		
	JoyOS <i>advisor</i> [™] feature	50		
	Quick Help	51		
	Settings	51		
	Sewing/Embroidery Mode Toggle	51		
5	WiFi & <i>mySewnet</i>[™] Services	53		
	WiFi Introduction	54		
	Getting Started With WiFi	54		
	Hidden Network	54		
	Firmware Update Using WiFi	55		
	Firmware Update Using a USB Device	56		
	Complimentary Software (PC)	57		

For PC and MAC computers.....	57	Sew On Button.....	86
mySewnet™ Services.....	58	Sensor Foot Pressure	87
mySewnet™ Account.....	58	deLuxe™ Stitch System.....	87
mySewnet™ Cloud.....	59	Mirroring.....	88
Used Space in mySewnet™ Cloud.....	59	Stitch Re-Start	88
Installation of mySewnet™ Cloud Sync Tool		Balance	88
for PC.....	60	Free Motion Options.....	88
mySewnet™ Portal	61	Sewing Recommendations.....	90
mySewMonitor App	61	Save Stitch	91
6 JoyOS advisor™.....	63	Smart Save	91
JoyOS advisor™ Introduction.....	64	Dimensional Stitches – Menu L.....	92
JoyOS advisor™ Project Menu	64	Theme Stitches – Menu M.....	92
JoyOS advisor™ Project Viewer	64	Embellished Stitches – Menu N	93
JoyOS advisor™ Project Viewer – Overview.....	65	Tapering Stitches – Menu Q	94
Pictures in JoyOS advisor™ Project Viewer.....	66	Taper Satin Stitch Exercise.....	94
Animations in JoyOS advisor™ Project Viewer.....	66	4-Way Stitches – Menu S.....	95
Stitch in JoyOS advisor™ Project Viewer.....	66	8-Way Stitches – Menu T	96
mySewnet™ Blog.....	66	Special Stitches For Optional Presser Feet.....	97
Search.....	67	Sewing Pop-up Messages.....	97
SEWING ADVISOR™ – Overview.....	68	8 Embroidery.....	99
Fabric Selection	69	Getting Started to Embroider.....	100
Sewing Technique Groups	70	Embroidery Edit – Overview.....	101
Basic Sewing Techniques	70	Load a Design.....	102
Start New	73	Load a Stitch.....	102
Continue	73	Load a Font	102
Load Smart Save	73	File Manager	102
Quilt Advisor.....	74	Toolbox.....	103
Quilting Technique Groups.....	74	Move to Hoop.....	103
EMBROIDERY ADVISOR™ – Overview.....	75	Delete	103
Background Color.....	76	Duplicate.....	103
Grid Options.....	76	Mirror Side to Side and End to End	104
Alignment.....	76	Stitch Out Design Earlier/Later.....	104
Embroidery Technique Groups	76	Group/Ungroup.....	104
Start New	76	Select All	105
Continue	76	Multi-Select.....	105
Load Smart Save	77	How to Select Designs	105
Knowledge Center – Overview.....	78	Hoop Selection.....	106
Stabilizer Guide	79	Touch Functions.....	107
Quick Start Guide	79	Position.....	107
Sewing Instructions	79	Rotate	107
Continue	79	Scale	108
7 Sewing.....	81	Pan.....	109
Getting Started to Sew.....	82	Zoom.....	109
Sewing Mode – Overview	83	Zoom Options	109
What is a Stitch?	84	Undo/Redo.....	110
Select a Stitch or Letter	84	Design Stitch Out Order	110
Load a Stitch or Letter From Another		Total Number of Stitches in Design	
Location.....	84	Combination.....	110
Stitch Settings	85	Save Design	111
Stitch Width.....	85	Smart Save	111
Stitch Positioning.....	85	GO.....	112
Stitch Length.....	85	Edit an Existing Design or Text.....	112
Stitch Density.....	86		
Button Size	86		

Thread Color Edit.....	113	Highlight Current Color Block	141
Program Embroidery Text	115	Basting Options	142
Create a Text	115	Embroidery Stitch Out Pop-up Messages	143
Add a Letter	115		
Delete a Letter.....	116	10 Program	145
Text Shaping	116	Program – Overview	146
Design Shaping	118	Create New Program	147
Design Shaping Exercise	118	To Edit a Created Program	148
Combination Repeat/Duplicate Last Design	119	Edit Stitch or Lettering Program.....	149
Edit Existing Shape	119	Adjust the Entire Program	150
Select Spacing.....	120	Stitch Program Commands.....	150
Select Line Positioning	120	Save Program.....	152
Select Side Positioning	120	Sew or Embroider Your Stitch Program	152
Fixed Design Angle	120	Program Pop-Up Messages.....	153
Set Number of Designs	120		
Design Appliqué	121	11 Settings.....	155
Resize	123	Temporary Sewing Settings.....	156
Resize Adjustments	124	<i>deLuxe</i> [™] Stitch System.....	156
Start Resizing	125	Sensor Presser Foot Lift	156
Important Resize Information	125	Automatic Thread Cutter.....	156
Embroidery Edit Pop-up Messages.....	126	Automatic FIX	156
		Stitch Limiting Options	156
9 Embroidery Stitch Out	127	Feed Teeth Options.....	156
Embroidery Stitch Out – Overview.....	128	Temporary Embroidery Settings	157
Welcome to Embroidery Stitch Out.....	129	<i>deLuxe</i> [™] Stitch System.....	157
Color Block List	130	Embroidery Foot Type.....	157
Zoom	131	Thread Cut Options	157
Zoom Options	131	Twin Needle Options.....	158
Corner Check.....	131	Default Sewing Settings	159
Hoop Position Options.....	131	<i>deLuxe</i> [™] Stitch System – Default.....	159
Current Stitch Position.....	131	Sensor Presser Foot Lift – Default	159
Park Position.....	131	Automatic Thread Cutter – Default.....	159
Trim Position	132	Automatic FIX – Default	159
Center/Remove Hoop Position	132	Free Motion Options – Default	159
Design Positioning.....	133	Default Embroidery Settings	160
Zoom to Cursor.....	133	<i>deLuxe</i> [™] Stitch System – Default.....	160
Set Cursor Point	134	Thread Cut Options – Default.....	160
Position and Rotate a Design	134	Embroidery Pivot Height – Default.....	160
<i>deLuxe</i> [™] Stitch System.....	137	My Hoops	160
Smart Save	137	Machine Settings	161
Auto Smart Save	138	Language	161
Thread Color Spools	138	Audio Volume	161
Return to Embroidery Edit	138	Audio Repeat	161
Step Stitch-by-Stitch/Go to Stitch	139	Machine Nickname.....	161
Number of Stitches in Current Color		Lock Screen	161
Block.....	139	LED Work Light Brightness.....	161
Number of Stitches in Embroidery		Units.....	161
Combination.....	139	Clock Settings.....	161
Remaining Embroidery Time by Color		Usage.....	161
Block.....	139	WiFi Settings.....	162
Color Options	140	<i>mySewnet</i> [™] Settings.....	162
Color Block Sort	140	Machine Information.....	162
Color Block Merge	140		
Monochrome	140	12 File Manager	163
		File Manager – Overview.....	164

File Formats	165
Browse File Manager.....	165
Open a File or Folder.....	165
Move Up One Folder Level	166
List/Thumbnail View	166
<i>mySewnet</i> ™ Cloud Folder	166
Built-in Designs	166
USB Device	166
Organize.....	167
Create New Folder	167
Rename a File or Folder	167
Move a File or Folder.....	167
Copy a File or Folder.....	167
Delete a File or Folder	168
Toggle Between Edit and Filter View.....	168
Filter Files.....	168
File Manager Pop-up Messages	169

13 Maintenance **170**

Cleaning the Machine Exterior.....	171
Removing the Needle Plate and Cleaning the Bobbin Area	171
Cleaning Under the Bobbin Area.....	171
Replacing the Needle Plate.....	172
Troubleshooting.....	172
Troubleshooting Connectivity	175
Service	175
Non-Original Parts and Accessories	175
Technical specification.....	175

14 IMPORTANT..... **177**

IMPORTANT SAFETY INSTRUCTIONS	177
DANGER –TO REDUCE THE RISK OF ELECTRIC SHOCK:.....	177
WARNING –TO REDUCE THE RISK OF BURNS, FIRE, ELECTRIC SHOCK, OR INJURY TO PERSON:	177
SAVE THESE INSTRUCTIONS.....	177
SERVICING OF DOUBLE INSULATED PRODUCTS	178
Licenses	178



I Introduction

Machine Overview

Front

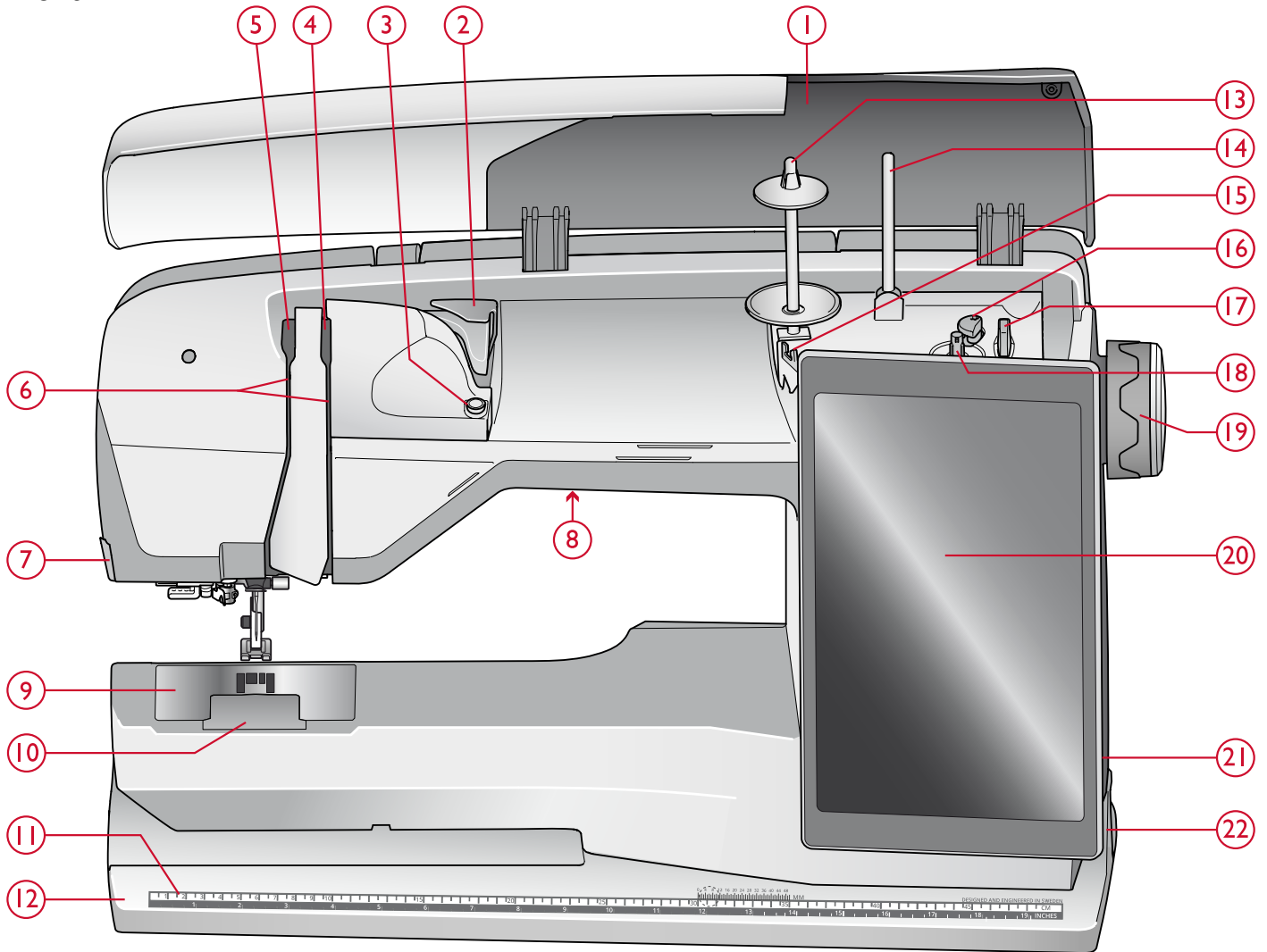

- | | |
|--|---|
| 1. Lid | 13. Main spool pin |
| 2. Pre-tension thread guide | 14. Auxiliary spool pin |
| 3. Thread tension disc for bobbin winding | 15. Bobbin winding thread guides |
| 4. Thread tension discs | 16. Bobbin winding lever |
| 5. Thread take-up lever | 17. Thread cutter for bobbin winding |
| 6. Threading slots | 18. Bobbin winder |
| 7. Thread cutter | 19. Handwheel |
| 8. LED light | 20. Multi-touch screen |
| 9. Needle plate | 21. Built-In USB ports |
| 10. Bobbin cover | 22. ON/OFF switch, connectors for power cord and foot control |
| 11. Button ruler and built-in tape measure | |
| 12. Base plate | |

Needle Area

1. Built-In needle threader
2. Needle bar
3. Needle clamp
4. Needle thread guide
5. Presser foot bar and presser foot ankle
6. Presser foot

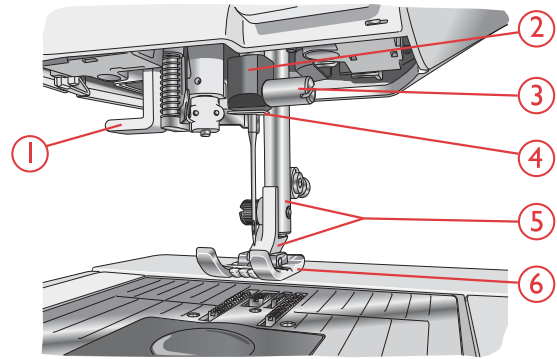

Rear

1. Handle
2. Accessory socket
3. Free arm
4. Embroidery unit socket

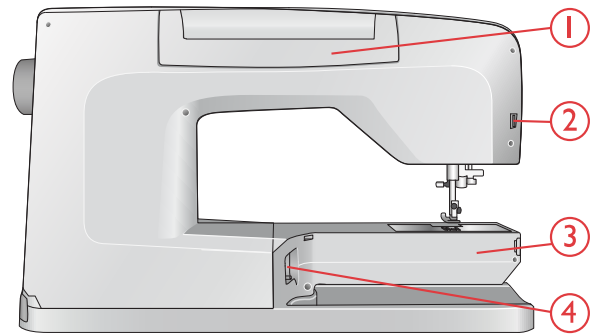

Accessory Tray

The accessory tray features special compartments for presser feet and bobbins, plus space for needles and other accessories. Store the accessories in the tray so that they are easily accessible.

1. Space for accessories
2. Spaces for presser feet
3. Removable bobbin holder
4. Holes for needles

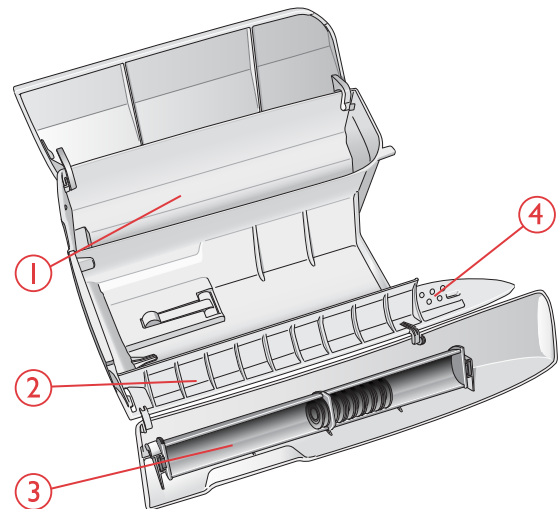

Embroidery Unit

(type BE 17)

1. Embroidery unit release button (underside)
2. Embroidery arm
3. Embroidery hoop attachment
4. Level adjustment feet
5. Embroidery unit plug

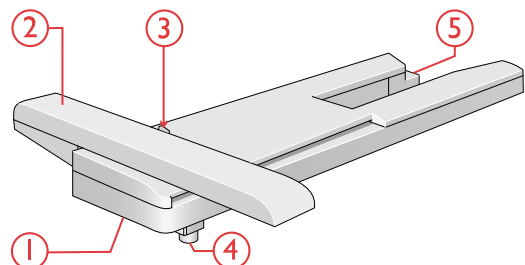

Function Buttons

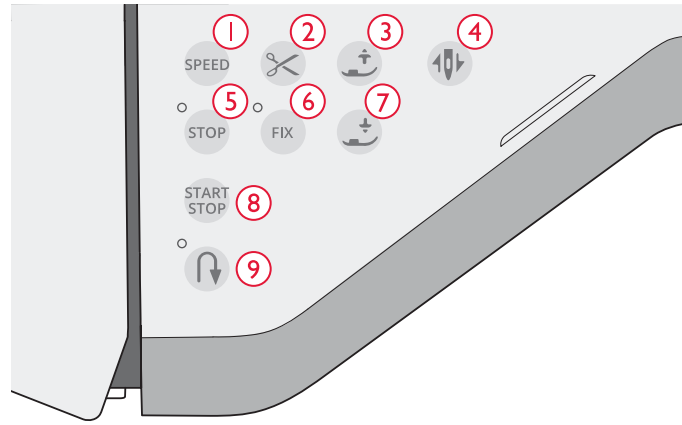

- 1. Speed
- 2. Selective Thread Cutter button
- 3. Needle stop up/down
- 4. Reverse
- 5. STOP function
- 6. FIX function
- 7. Presser foot down and pivot
- 8. Start/stop
- 9. Reverse

Speed

All stitches and embroideries in your machine have a pre-set, maximum allowed sewing speed to provide a good stitch result.

The machine will never sew faster than the maximum allowed sewing speed for the selected stitch/embroidery. Touch the speed button when the machine is not running and a pop-up on the screen will indicate the speed setting. You can set the speed by touching the slider in the pop-up or by touching the speed button. Each touch of the speed button increases the sewing speed one step. If the machine is set to maximum speed, each touch will instead decrease the sewing speed until minimum speed. Then each touch increases the speed again. If you change the speed setting while sewing no pop-up will appear.

Needle Stop Up/Down

Touch needle stop up/down to set the position of the needle when you stop sewing. The needle will move up or down when you touch the button. When needle stop down is set, a needle icon with an arrow pointing down is shown on the screen.

Tip: You can also tap the foot control to raise or lower the needle once you stop sewing. Tapping the foot control does not change the set stop position.

Cut Function

Touch the cut function button and your machine cuts the upper and bobbin threads, raises the presser foot and needle, and activates the FIX function for the next start.

To cut threads at the end of a stitch or stitch program, touch the cut function button while sewing. A scissor icon will flash on the screen, alerting you that a cut is requested. When the stitch or stitch program is completed, your machine cuts the

upper and bobbin threads, raises the presser foot and needle, and activates the FIX function for the next start.

Note: If automatic FIX and selective presser foot lift has been deselected in temporary sewing settings, FIX function will not be activated and presser foot will not be raised when using the cut function.

Touch the cut function button when embroidering and your machine cuts the upper and bobbin threads instantly.



Some optional accessories are attached in the two small circular holes in the needle plate just above the bobbin cover. Do not use the cut function when an accessory is attached in these holes as that may interfere with the automatic thread cutter located under the needle plate.

Reverse

When reverse is active, the reverse indicator is lit. For permanent reverse, touch the reverse button once before starting to sew. The reverse indicator will be lit and the machine sews in reverse until you touch the button again to cancel. If you press the reverse button while sewing, the machine will sew in reverse for as long as you keep the button pressed.

Reverse is also used when sewing for example manual buttonholes, darning stitches and tapering stitches to step between the parts of the stitch.

Start/Stop

Touch the start/stop button to start and stop the machine sewing or embroidering without using the foot control. Touch start/stop to begin and touch again to stop.

FIX function

FIX is used to tie off a stitch. Touch the button to turn the function on/off. The indicator next to the FIX function

button is lit when the FIX function is active. When beginning to sew with FIX function active, your machine sews a few tie-off stitches and continues with the selected stitch. Touch FIX while sewing and your machine sews a few tie-off stitches and stops automatically.

You can activate automatic FIX in settings, see Automatic FIX.

STOP function

Touch STOP when sewing to conclude a stitch or stitch program. Your machine fixes the thread and stops automatically when the stitch or stitch program has been completed. Touch STOP before starting to sew and your machine sews only one repetition of the stitch. Only one stitch is displayed on the screen. The indicator next to the STOP button is lit when the STOP function is active. To cancel the function, touch STOP again or select a new stitch. The STOP function is cancelled when the stitch is completed.

The STOP function is also used to repeat a sewn length when sewing tapering, (see Tapering Stitches – Menu Q) and when sewing manual buttonholes.

Presser Foot Down and Pivot

The presser foot is lowered automatically when you start sewing. To lower the presser foot before starting to sew, touch the presser foot down and pivot button. The presser foot will be completely lowered and the machine firmly holds the fabric. Touch presser foot down again to go to pivot position.

In embroidery mode touch presser foot down to lower the presser foot to embroidery position.

Presser Foot Up and Extra Lift

Touch the presser foot up button once to raise the presser foot. Touch again and the presser foot will raise to extra lift position, and the feed teeth will be automatically lowered to make it easier to get heavy fabric under the presser foot.

In embroidery mode, the extra lift makes it easier to insert or remove the hoop.

Basic Gestures for the Multi-Touch Screen

Easily navigate on the multi-touch screen with the gestures described below. For more detailed information, see Multi-Touch Screen.

Touch

Touch once on a button or setting on the screen to select.

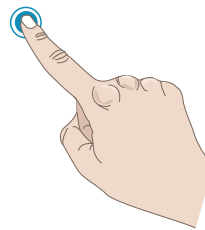

Touch & Hold

Touch once without releasing for a few seconds to touch & hold. Used on some buttons and screen areas to access more options.

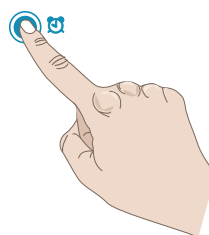

Pinch/Stretch

Touch with two fingers at the same time and without releasing increase/reduce the distance between the fingers to stretch (zoom in) or pinch (zoom out).

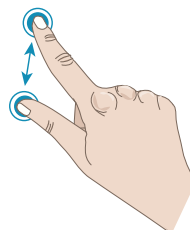

Touch and Move

Touch once on a selected design and, without releasing, move your finger to a different position on the screen. Used e.g. for moving a design in the embroidery area.

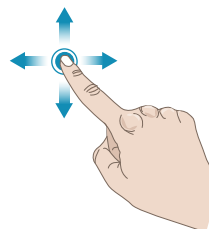

Swipe

Touch, move and release your finger in a swift gesture to swipe. Left-right/right-left swipe is used e.g. to scroll between stitch menus. Top-bottom/bottom-top swipe is used e.g. to scroll within a stitch menu.

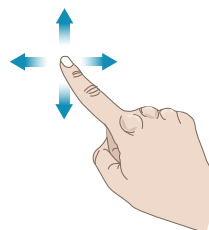

Accessories

Included Accessories

1. Thread net (2)
2. Screwdriver
3. Seam ripper
4. Brush
5. Edge/Quilting guides (used attached to presser foot ankle or together with the Dual Feed Foot)
6. Felt pad (2)
7. Spool cap, small (1)
8. Spool cap, medium (1)
9. Spool cap, large (2)
10. Bobbins (11)
11. Hoop clips (16)
12. Multipurpose tool/Button reed
13. Straight Stitch Plate

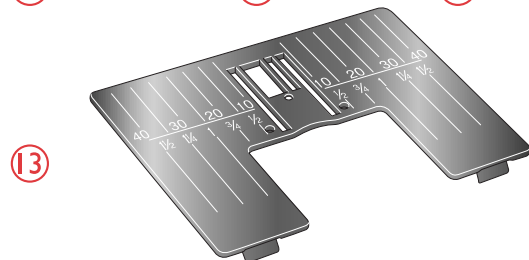
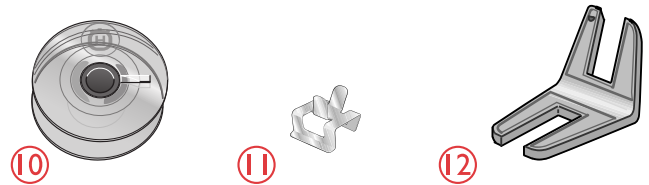
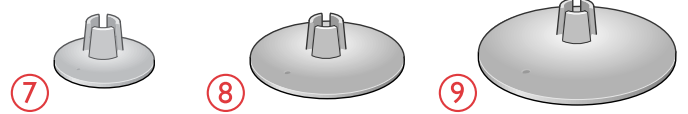
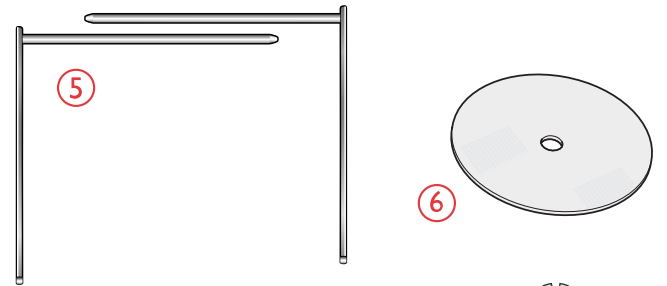
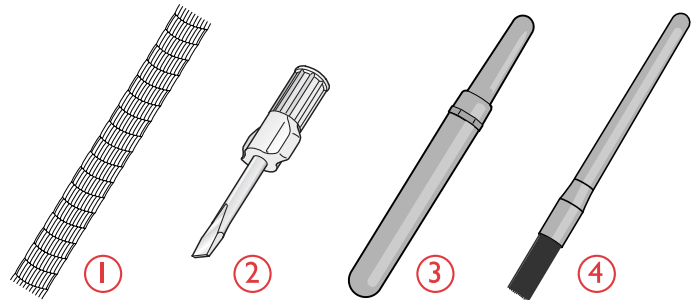

Included Accessories Not in Picture

- Complimentary software (PC) to download, see Complimentary Software (PC).
- Hard cover for machine
- Luggage style carrying bag with packing insert for embroidery unit
- Foot control
- Power cord
- Needles
- DESIGNER BRILLIANCE™ 80 Sampler book
- Scissors
- Embroidery thread
- Pieces of fabric and stabilizer
- Microfiber cloth

Included Hoops

1. DESIGNER™ Royal Hoop (360x200)
2. DESIGNER™ Crown Hoop (260x200)
3. DESIGNER™ Splendid Square Hoop (120x120)

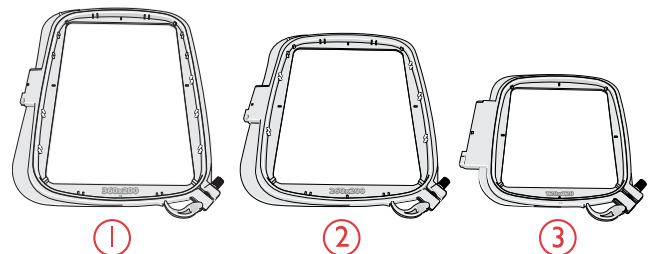

Presser Feet

Note: For the best sewing results, use only presser feet designed for and compatible with your DESIGNER BRILLIANCE™ 80 machine.

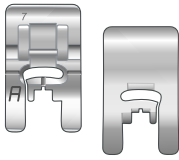

Utility Foot A

Snapped onto the machine upon delivery. Used mainly for straight stitching and zigzag stitching with a stitch length longer than 1.0mm.

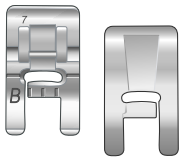

Decorative Stitch Foot B

For sewing close zigzag stitches (satin stitches) with less than 1.0mm stitch length, other utility stitches or decorative stitches, use this foot. The tunnel on the underside of the foot is designed to feed smoothly over the stitches.

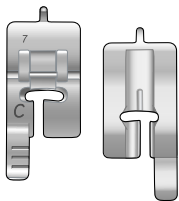

Buttonhole Foot C

For manual buttonholes. This foot has guidelines to determine buttonhole length. The middle measures $\frac{5}{8}$ " (15mm) from the fabric edge. The two tunnels on the underside of the foot ensure smooth feeding over the buttonhole columns. The finger on the back of the foot holds cording for corded buttonholes.

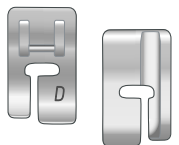

Blindhem Foot D

For blindhem stitches. The inner edge of this foot guides the fabric. The right toe of the foot is designed to ride along the hem edge.

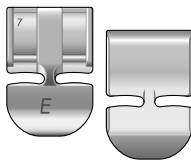

Zipper Foot E

This foot can be snapped on either to the right or to the left of the needle. This makes it easy to sew both sides of the zipper. Move needle position to right or left to sew closer to zipper teeth or for covering large cording.

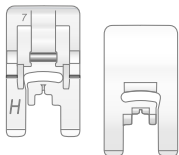

Non-Stick Glide Foot H

This foot, with a non-stick coating underneath, is used when sewing foam, vinyl, plastic, or leather to keep these materials from sticking to the foot.

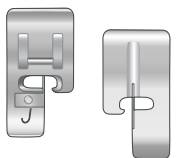

Edging Foot J

Used for overcasting and seam/overcasting, with stitches that have a stitch width of 5.0 and 5.5mm. Stitches form over the pin which prevents puckering at the edge of the fabric.

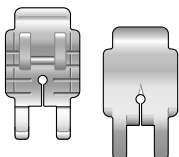

Quilter's $\frac{1}{4}$ " Piecing Foot P

Used when piecing quilt blocks. The foot has distance guideline marks $\frac{1}{4}$ " (6mm) and $\frac{1}{8}$ " (3mm) from the needle.

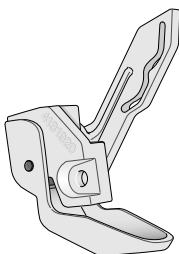

Sensor Q-Foot

The Sensor Q-Foot is recommended for hoop embroidery.

This foot is also used for free motion sewing, free motion quilting and free motion embroidering. When using the Sensor Q-Foot for free motion, select free motion spring action in the free motion options pop-up in sewing mode.

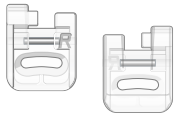

Embroidery/Darning Foot R

Used for free motion embroidery, free motion quilting, free motion stitching and free motion darning. When using this foot, select free motion floating in the free motion options pop-up in sewing mode.

This foot can also be used for hoop embroidery.

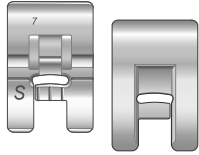

Side-Motion Foot S

Used for side-motion/omnimotion stitches.

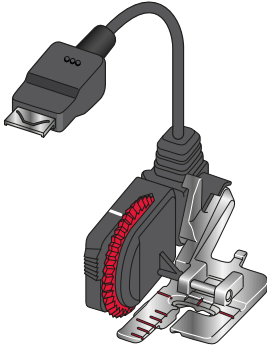

Sensor One-Step Buttonhole Foot

Plug into the machine then enter the desired buttonhole length to sew sensor one-step buttonholes. The middle mark measures a $\frac{5}{8}$ " (15mm) from fabric edge.

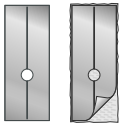

Self-Adhesive Glide Plates

If sewing on foam, vinyl, plastic, or leather, the material can stick to the foot and prevent the sewing machine from feeding properly. When using any of the above materials, sew on a piece of scrap fabric, to make sure the machine feeds smoothly. If not, fasten the self-adhesive glide plate to the underside of the presser foot.

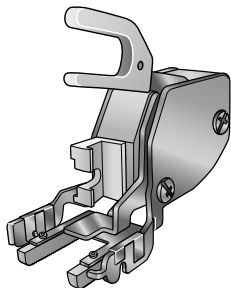





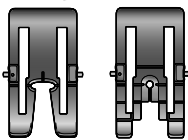













Interchangeable Dual Feed

















The Dual Feed Foot with changeable presser feet is designed to feed layers of fabric and/or batting evenly. It is perfect for quilting, sewing velvet, stretch fabrics, imitation leathers and fabrics that need precise pattern matching. Snap on the Changeable Straight Stitch Foot when using the straight stitch in the center needle position with a stitch length up to 6mm. Snap on the Changeable Zigzag Foot when selecting stitches up to 7mm wide and 6mm long.









Stitch Overview

Utility Stitches

Stitch	Nº	Presser foot	Name	Description
	A1	A	Straight stitch, center needle position	For all types of sewing.
	A2	A	Straight stitch with reinforced tie-off	For all types of sewing. Begins and ends with forward and reverse stitches.
	A3	A	Stretch stitch, left needle position	For seams in tricot and stretch fabrics.
	A4	A	Zigzag, center needle position	For sewing on lace, trims and appliqués.
	A5	A	Reinforced straight stitch, center needle position	Triple and elastic, for reinforced seams. For top stitch, increase the stitch length.
	A6	B	Reinforced zigzag stitch	For joining fabric edge to edge or overlapping in leather. For decorative sewing.
	A7	J	Seam/overcast stitch	Seam and overcast in one step along the edge or trim later. For light stretch and non-stretch fabrics.
	A8	B	Stretch seam/overcast stitch	Seam and overcast in one step along the edge or trim later. For medium and heavy stretch fabrics.
	A9	B	Double overlock stitch	Seam and overcast in one step along the edge or trim later. For heavy stretch and heavy woven fabrics.
	A10	B	Overlock stitch	Seam and overcast in one step along the edge or trim later. For medium stretch fabrics.
	A11	B	Flatlock stitch	Decorative hems and overlapped seams, belts and bands. For medium/heavy stretch fabrics.
	A12	D	Stretch blind hem stitch	Blind hems in medium and heavy stretch fabrics.
	A13	D	Woven blind hem stitch	Blind hems in medium and heavy woven fabrics.
	A14	A	Shell edge stitch	For edging, sewing over the edge on light woven fabrics. Sew woven fabrics on bias.
	A15	A	Four-step zigzag	For overcasting, mending, sewing on patches and elastics on loosely woven fabrics.
	A16	B	Elastic/casing stitch	For overlapped seams in tricot. To sew casing over narrow elastic.
	A17	A	Serpentine stitch	For mending and elastic applications.
	A18	B	Elastic or smocking stitch	Sew over two rows of elastic thread for elastic shirring.
	A19	B	Bridging stitch	For joining two pieces of fabric with finished edges and for elastic shirring.

Stitch	№	Presser foot	Name	Description
	A20	J	Three-step zigzag	For overcasting, mending, sewing on patches and elastic. Suitable for light and medium weight fabrics.
	A21	A	Two-step zigzag	For joining two pieces of lace, and for elastic shirring.
	A22	B	Bartack, manual	Reinforce pockets, shirt openings, belt loops as well as at lower end of a zipper.
	A23	A	Darning stitch (forward and backward)	Darn and mend small holes in work clothes, jeans, tablecloths and linen towels. Stitch over hole, touch reverse for continuous darning and auto stop.
	A24	A	Darning stitch (side to side)	For mending small tears.
	A25	A	Reinforced darning stitch	Darn and mend work clothes, jeans, tablecloths and linen towels. Stitch over hole, touch reverse for continuous darning and auto stop.
	A26	B	Darning stitch (four-step)	A group of four stitches perfect for mending small tears. Stitch #1 and #3 are sewn in a forward motion, stitch #2 and #4 are sewn backwards. To change stitch and direction touch the reverse button. <i>Tip: Press fusible interfacing on the wrong side before mending the tear.</i>
	A27	A	Belt loop stitch	For securing belt loops.
	A28	A	Straight basting stitch	To baste, press the foot control and the machine will make two stitches, stop and raise the foot. When the presser foot lifts, move the fabric to the next baste position and press the foot control. Feed teeth lowered automatically.
	A29	A	Zigzag basting	To baste, press the foot control and the machine will make two stitches, stop and raise the foot. When the presser foot lifts, move the fabric to the next baste position and press the foot control. Feed teeth lowered automatically.
	A30	Sensor Buttonhole foot/C	Wide bartack buttonhole	For medium and heavy fabrics with extra cutting space.
	A31	Sensor Buttonhole foot/C	Round end buttonhole	For blouses and children's garments.
	A32	Sensor Buttonhole foot/C	Keyhole buttonhole	Square end for tailored jackets, coats, etc.
	A33	Sensor Buttonhole foot/C	Tapered keyhole buttonhole	Tapered end for tailored garments.
	A34	Sensor Buttonhole foot/C	Decorative fashion buttonhole	For most fabric weights.
	A35	Sensor Buttonhole foot/C	Heavy duty buttonhole	With reinforced bartacks
	A36	Sensor Buttonhole foot/C	Heavy reinforced buttonhole	For utility and heavy fabrics.

Stitch	№	Presser foot	Name	Description
	A37	Sensor Buttonhole foot/C	Medium Reinforced Buttonhole	For medium and heavy fabrics.
	A38	Sensor Buttonhole foot/C	Rounded heirloom buttonhole	For hand look on fine and delicate fabrics.
	A39	A	Leather buttonhole (straight stitch)	For leather and suede.
	A40	A	Bound buttonhole (straight stitch)	With extra cutting space for bound buttonholes.
	A41	-	Automatic button sewing	For sewing on buttons.
	A42	B	Round eyelet	For belts, laces, etc.

Stitch Menu Overview

There are several different stitch menus with stitches for all purposes. For detailed description of a stitch, use the quick help function, see Quick Help.

Stitch Menu Name	Description
A — Utility Stitches	Stitches for garment sewing and mending.
B — Appliqué Stitches	For sewing appliqués with different effects.
C — Heirloom Stitches	Decorative stitches for traditional heirloom sewing. Stitches for hemstitching, smocking and sewing on laces and trims.
D — Quilt Stitches	Stitches for all types of quilting techniques.
E — Crafting Stitches	Decorative stitches to embellish crafts.
F — Decorative Stitches	For decorative sewing.
G — Vintage Stitches	A selection of quilt stitches for crazy patch quilting and decorative stitching.
H — Children Stitches	Stitches suitable for sewing on children's clothes and projects.
J — Scallop Stitches	Create scallop details and finish edges with beautiful scallop stitches.
K — Omnimotion Stitches	Program these stitches into an unlimited number of combinations. Stitches are formed with side motion. The stitch width can be up to 49mm wide.
L — Dimensional Stitches	Includes three types of stitches: appliqué and pop-up stitches, combinations of these two types, and sequin stitches.
M — Theme Stitches	Each stitch number on this menu contains a group of four stitches designed to be sewn out together in random combinations. Change to the next stitch in the selected group by touching the reverse button.
N — Embellished Stitches	Decorative stitches that can be used as they are, or further embellished after sewing. Use quick help for detailed information.
O — Single Motif Stitches	Single stitches for embellishment. The machine stops after one sewn repetition.
P — Specialty Stitches	Sew special techniques including candlewicking, edging and more. Extra accessories may be needed. Use quick help for detailed information.
Q — Decorative Tapering Stitches	Decorative stitches with tapering.
R — Pictogram Stitches	Pictogram satin elements to program original satin stitch designs.
S — 4-Way Stitches	Four directional sewing and patching using the free arm.
T — 8-Way Stitches	Straight stitch and reinforced straight stitch in eight different directions without turning the fabric. Can be programmed with decorative stitches to create unique borders.

Alphabets

Stitch fonts are available in block, outline, brush line, script and Cyrillic alphabets.

2 Preparations

Unpacking Machine and Embroidery Unit

After lifting the machine out of the box and removing all packing material and the plastic bag, wipe the machine, particularly around the needle and needle plate to remove any oil before sewing.

When unpacking the embroidery unit, do not throw away the black styrofoam inside the embroidery unit carrying bag, as this is designed for storing the embroidery unit when not in use.

Note: Your DESIGNER BRILLIANCE™ 80 machine is adjusted to provide the best stitch result at normal room temperature. Extreme hot and cold temperatures can affect the sewn result.

Connect the Power Cord and Foot Control

Among the accessories you will find the power cord and the foot control.

Note: Before plugging in the foot control, check to ensure that it is type "FR5" (see underside of foot control).

1. Pull out the cord from the foot control. Connect the foot control cord to the front socket on the bottom right side of the machine.
2. Connect the power cord to the rear socket on the bottom right side of the machine. Plug the cord into the wall socket.
3. Press the ON/OFF switch to "I" to turn on power and light.

For the USA and Canada

This sewing machine has a polarized plug (one blade wider than the other). To reduce the risk of electric shock, this plug is intended to fit in a polarized outlet only one way. If the plug does not fit fully in the outlet, reverse the plug. If it still does not fit, contact a qualified electrician to install the proper outlet. Do not modify the plug in any way.

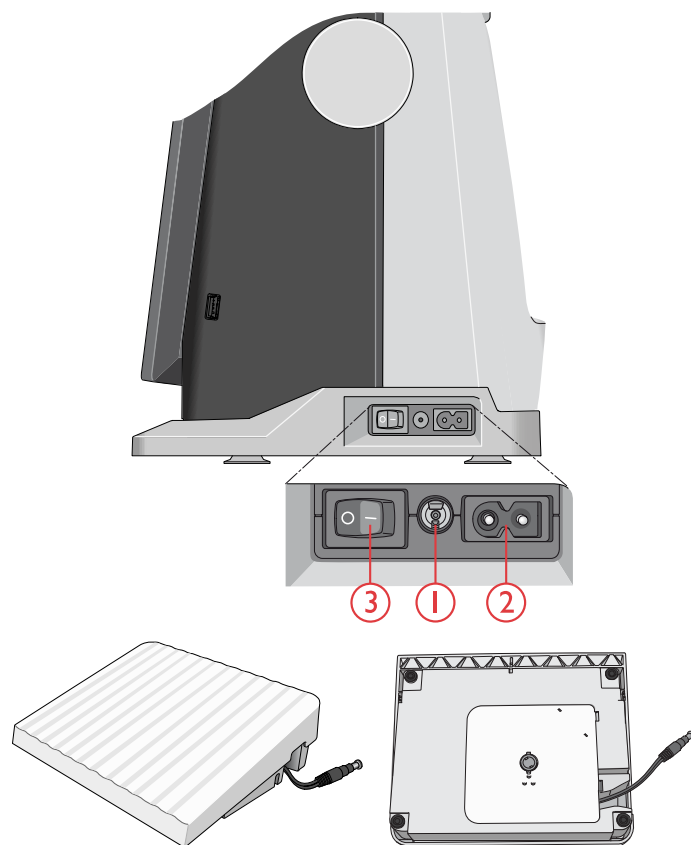

Pack Away After Sewing

1. Press the ON/OFF switch to "O".
2. Unplug the cord from the wall socket and then from the machine.
3. Unplug the foot control cord from the machine. Pull the cord gently and release. The cord will retract into the foot control.
4. Place all accessories in the accessory tray. Slide the tray on to the machine around the free arm.
5. Place the foot control in the space above the free arm.
6. Put on the hard cover.

Tip: The user's guide and power cord can be stored in the back pocket of the hard cover.

USB Port

Your machine has a USB port for connecting USB devices such as a memory stick. USB plugs can only be inserted one way – do not force them into the port! To remove, carefully pull the USB device straight out.

Note: Make sure that the USB stick you use has the format FAT32.

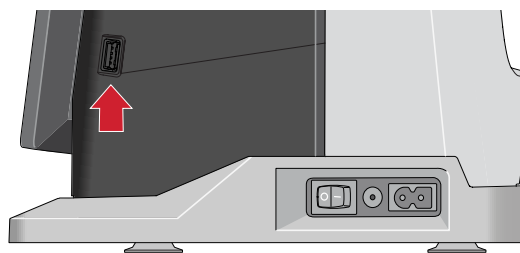

Using a USB device

The external device button in file manager is only active when a device is connected to the machine USB port.

Note: Do not remove the USB device if a loading spinner is shown on the screen or while the file manager is shown. Removing the device at that time can damage the files on your USB device.

Read more in File Manager – Overview.

Getting Started with WiFi and mySewnet™ Cloud

Follow the steps below to connect your machine.

Connect to a Network with WiFi

Touch the WiFi button in the top left corner of the screen. Select from the list of available networks. If your network is password protected, you will be prompted to enter the password to connect.

For more information, see WiFi Introduction.



WiFi button

Connect to mySewnet™ Cloud

When you have established a WiFi connection, touch the cloud button next to the WiFi button on the screen. Touch the button to sign in. A web view opens where you can log in. If you do not have a user name and password, select Register to create an account.

For more information, see mySewnet™ Cloud.



mySewnet™ cloud button

LED Lights

Your machine has LED lights which distribute the light evenly over the sewing area and eliminate shadows. You can adjust the brightness of the light in the settings menu, see LED Work Light Brightness .

Free Arm

To use the free arm, slide off the accessory tray. When attached, a hook keeps the accessory tray locked to the machine. Remove the tray by sliding it to the left.

Manual Thread Cutter

There are three manual thread cutters on your machine.

- The first one (A) is close to the bobbin winder spindle for cutting the thread before and after winding.
- The second one (B) is on the left side of the machine for manually cutting top and bobbin threads. Pull both threads into the cutter from the back to the front and pull down quickly.
- The third one (C) is next to the bobbin area for cutting the bobbin thread after placing the bobbin in the machine.

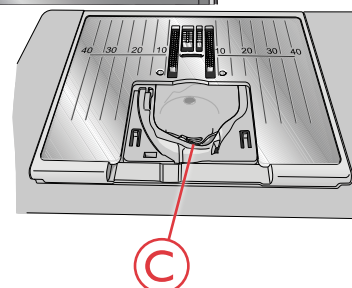
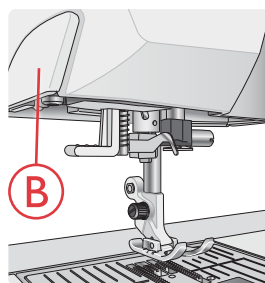
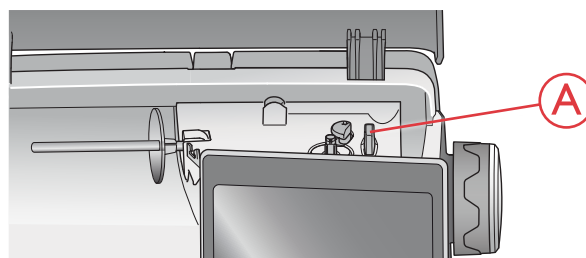

Thread Sensor

- If the needle thread breaks or bobbin thread is running low, the machine stops and a pop-up appears on the screen. If needle thread breaks: Remove the thread completely, re-thread the machine and touch OK in the pop-up.
- If bobbin thread is running low: You can continue sewing without closing the pop-up before the bobbin thread runs out completely. This gives you an opportunity to plan where to stop and change the bobbin. When the bobbin is replaced with a full one, touch OK in the pop-up.

Spool Pins

Your machine has two spool pins; a main spool pin and an auxiliary spool pin.

The spool pins are designed for all types of thread. The main spool pin is adjustable and can be used both in a horizontal position (the thread reels off the spool) and a vertical position (the thread spool rotates). Use the horizontal position for regular sewing threads and the vertical position for large spools or specialty threads.

Horizontal Position

Place a spool cap and the thread spool on the spool pin. Make sure that the thread reels off the spool counter clockwise and slide on a second spool cap.

Note: Not all thread spools are manufactured in the same way. If you experience problems with the thread, turn it in the opposite way or use the vertical position.

Use a spool cap slightly larger than the thread spool. For narrow thread spools, use a smaller spool cap in front of the spool. For large thread spools, use a larger spool cap in front of the spool.

The flat side of the spool cap should be pressed firmly against the spool. There should be no space between the spool cap and the thread spool.

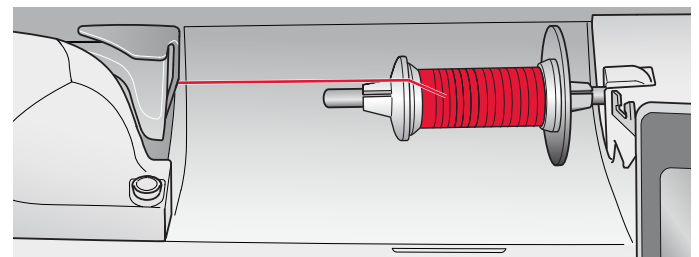
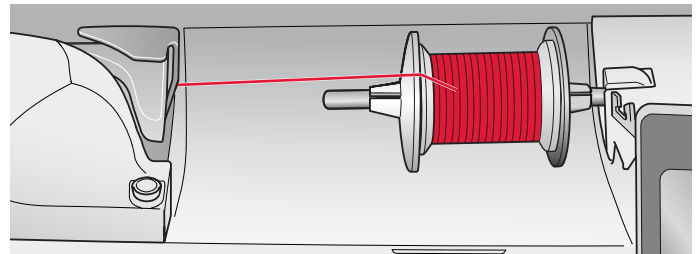

Vertical Position

Raise the spool pin to the vertical position. Slide on the large spool cap. For spools smaller than the medium size spool cap, place a felt pad under the thread spool to prevent the thread from reeling off too fast. Place thread spool on the spool pin.

Note: Do not place a spool cap on top of the vertical spool pin as it may prevent the spool from rotating.

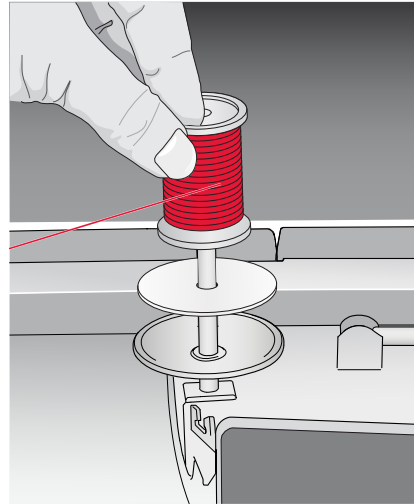

Auxiliary Spool Pin

The auxiliary spool pin is used when winding a bobbin from a second spool of thread or for a second spool when sewing with a twin needle.

Raise the auxiliary spool pin. Slide on a large spool cap and place a felt pad under the thread spool. Place thread spool on auxiliary spool pin.

Note: When sewing with two needle threads, deactivate deLuxe™ Stitch System.

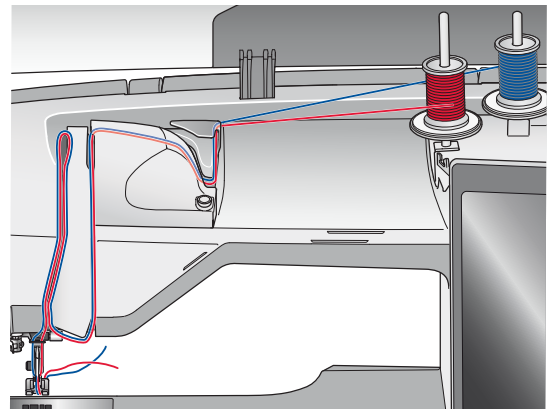
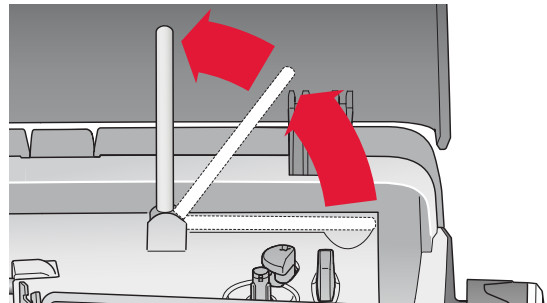

Threads

There are many threads on the market today developed for different purposes.

All Purpose Sewing Thread

All purpose sewing thread is made of synthetic, cotton or cotton covered polyester. This type of thread is used for most sewing projects, including garments, home decor, and quilting.

Embroidery Thread

Embroidery thread is made from a variety of fibers: rayon, polyester, acrylic or metallic. These threads create a smooth glossy appearance for embroidery and other decorative stitching.

Embroidery thread is not typically used in the bobbin unless both sides of the project will be seen. A light weight, embroidery bobbin thread is often used in the bobbin instead. The lighter weight thread does not build up under the embroidery.

Note: When using a metallic or a flat film thread for embroidery, you may need to use a needle with a larger eye and lower the embroidery speed.

Transparent Thread

Transparent thread, also called monofilament thread, is a single clear synthetic thread. It is used for quilting and other decorative sewing. When winding a bobbin, wind at half speed and fill the bobbin half full.

Needles

The sewing machine needle plays an important role in successful sewing. Use only quality needles. We recommend needles of system 130/705H. The needle package included with your machine contains needles of the most frequently used sizes.



Be sure to match the needle to the thread you are using. Heavier threads require a needle with a larger needle eye.

Universal Needle

Universal needles have a slightly rounded point and come in a variety of sizes. For general sewing in a variety of fabric types and weights.

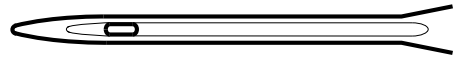

Stretch Needle

Stretch needles have a special scarf to eliminate skipped stitches when there is a flex in the fabric. For knits, swimwear, fleece, synthetic suedes and leathers.

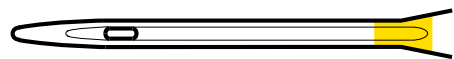

Embroidery Needle

Embroidery needles have a special scarf, a slightly rounded point and a slightly larger eye to avoid damage to thread and materials. Use with metallic and other specialty threads for embroidery and decorative sewing.

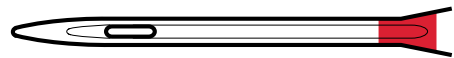

Denim Needle

Denim needles have a sharp point to penetrate tightly woven fabrics without deflecting the needle. For canvas, denim, microfibers.

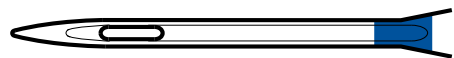

Wing Needle

Wing needles have wide wings on the side of the needle to poke holes in the fabric when sewing entredeux and other hemstitches on natural fiber fabrics.

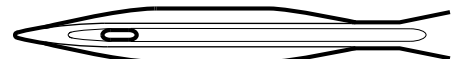

Important Needle Information

Change the needle often. Always use a straight needle with a sharp point (A).

A damaged needle (B) can cause skipped stitches, breakage or snapping of the thread. It can also damage the needle plate.

Do not use asymmetrical twin needles (C), they can damage your sewing machine.

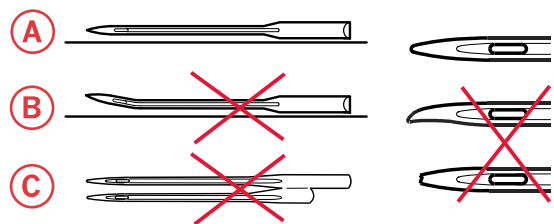

Changing the Needle

1. Use the hole in the multipurpose tool to hold the needle.
2. Loosen the needle screw with the screwdriver.
3. Remove the needle.
4. Insert the new needle using the multipurpose tool. Push the new needle upwards with the flat side away from you until it will go no further.
5. Tighten the needle screw with the screwdriver.

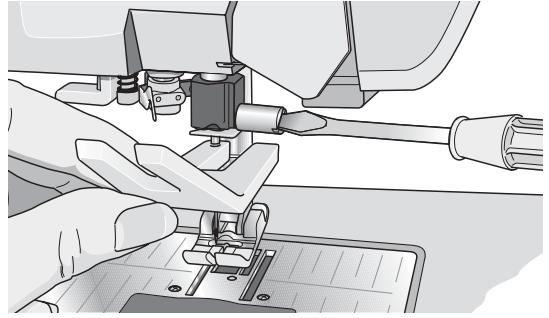

Threading the Upper Thread

Make sure that the presser foot is raised and the needle is in the up position.

Horizontal Spool Pin

1. Hold the thread near the spool using your right hand.
2. Use your left hand to bring the end of the thread over and behind the Pre-Tension Thread guide (A) and under the thread guide (B). Bring the thread between the thread tension discs (C).
3. Continue threading in the direction indicated by the arrows. Bring the thread from the right when threading into the slot on the take-up lever (D).
4. Take the thread down into the last thread guide (E) just above the needle.

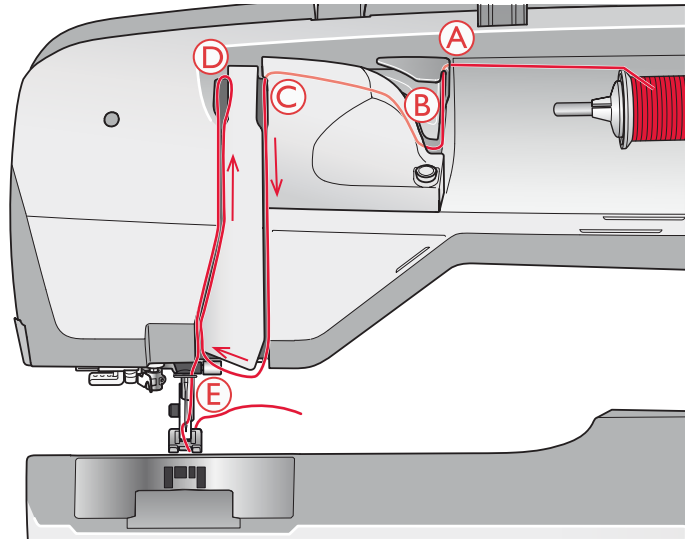

Needle threader

The needle threader allows you to thread the needle automatically. The needle must be in the up position to use the Built-In needle threader.

1. Lower the presser foot.
2. Use the handle to pull the needle threader all the way down. The threader hook (A) swivels through the needle eye.
3. Place the thread from the back over the hook (B) and under the thread hook (A).
4. Let the needle threader gently swing back. The hook pulls the thread through the needle eye and forms a loop behind the needle. Pull the thread loop out behind the needle.

Note: The needle threader is designed to be used for size 70-120 needles. You cannot use the needle threader for needles size 60 or smaller, the wing needle, twin needle, triple needle or when the Sensor One-Step buttonhole foot is attached. There are also some optional accessories that require manual threading of the needle.

When threading the needle manually, make sure that the needle is threaded from front to back. The bobbin cover can be used as a magnifying glass to make threading easier.

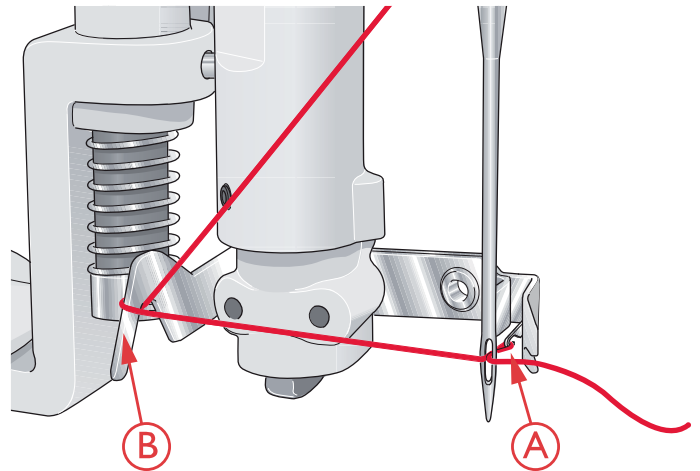
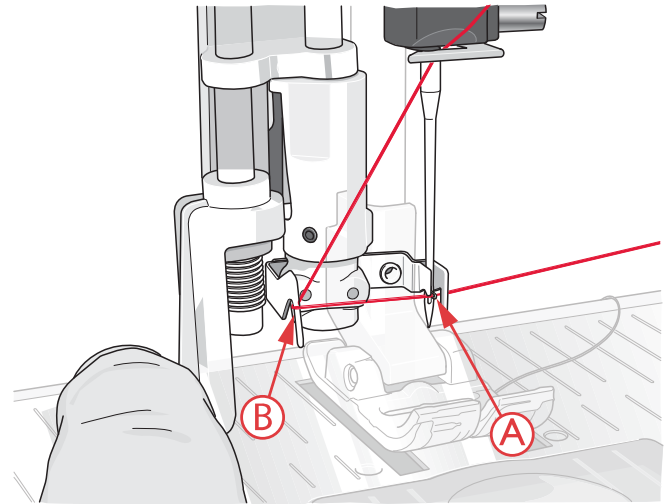

Selecting Correct Thread/Needle Combination

Fabric		Thread	Needle
Woven light	Chiffon, organza, batiste, challis, crepe de chine, etc.	Light weight threads: <ul style="list-style-type: none"> • fine cotton, polyester or silk sewing thread • rayon embroidery thread 	Universal 130/705H 70/10-80/12
Woven medium	Calico, quilting fabrics, crepe, broadcloth, velvet, etc.	Medium weight threads: <ul style="list-style-type: none"> • fine/normal cotton or polyester sewing thread • rayon embroidery thread 	Universal 130/705H 80/12-90/14
Woven heavy	Denim, tweed, canvas, terrycloth, etc.	Medium/heavy weight threads: <ul style="list-style-type: none"> • normal cotton or polyester sewing thread • top stitching thread • rayon embroidery thread 	Universal 130/705H 90/14-110/18
Stretch light	Tricot, single knit jerseys, etc.	Light weight threads: <ul style="list-style-type: none"> • fine cotton or polyester sewing thread • rayon embroidery thread 	Stretch 130/705H-S 75/11
Stretch medium	Sweater knits, double knit, velour, swimwear, etc.	Medium weight threads: <ul style="list-style-type: none"> • normal cotton or polyester sewing thread • rayon embroidery thread 	Stretch 130/705H-S 90/14
Stretch heavy	Sweater knits, fleece, etc.	Medium weight threads: <ul style="list-style-type: none"> • normal cotton or polyester sewing thread • rayon embroidery thread 	Stretch 130/705H-S 90/14
Leather	Suede and leather	Medium weight threads: <ul style="list-style-type: none"> • normal cotton or polyester sewing thread • rayon embroidery thread 	Stretch 130/705H-S 90/14
Vinyl	Vinyl, faux leather and suede	Medium weight threads: <ul style="list-style-type: none"> • normal cotton or polyester sewing thread • rayon embroidery thread 	Universal 130/705H 80/12

Note: Specialty fabrics and threads may require a special needle for best stitch results. Refer to your HUSQVARNA VIKING® retailer for more information on needle types and sizes for your sewing needs.

Threading for Twin Needle

Replace the sewing needle with a twin needle. Make sure the presser foot is raised and the needle is in the up position.

1. Raise the horizontal spool pin to the vertical position. Raise the auxiliary spool pin to the vertical position. Slide a large spool cap and a felt pad on each one. Place the thread spools on the spool caps.
2. Bring the thread over and behind the Pre-Tension Thread guide (A) and under the thread guide (B). Follow the thread slot and place the thread between the thread tension discs (C). Make sure that one thread is on each side of the tension discs.
3. Thread down through the right-hand threading slot and then upwards through the left-hand threading slot.
4. Bring the threads from the right into the take-up lever (D) and down in the left-hand threading slot. Make sure that one thread is inside the needle thread guide (E) and the other one outside. Also make sure that the threads do not become twisted together.

Note: The weight and irregular surface of specialty threads such as metallic increases the amount of friction on the thread. By reducing the tension, the risk of needle breakage and thread breakage is reduced.

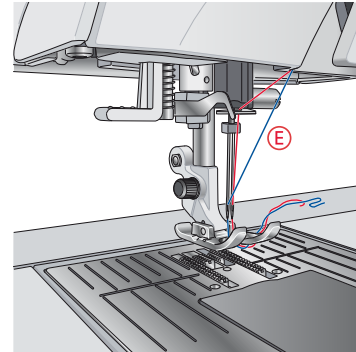
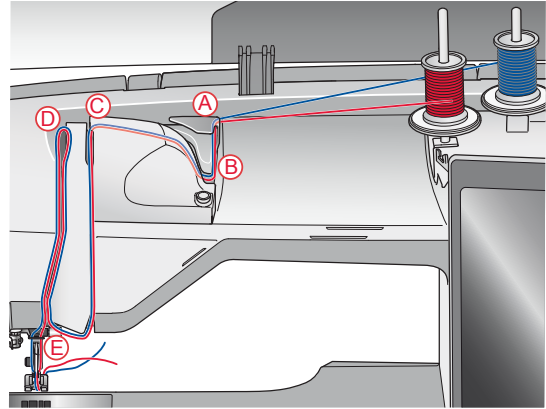

Bobbin Winding

Bobbin Winding through the needle

Make sure that the presser foot and the needle are in the up position.

1. Place an empty bobbin on the bobbin spindle on the top of the machine. The bobbin only fits on one way, with the logo facing up. Use only original HUSQVARNA VIKING® bobbins.
2. Thread the machine with the main spool pin in the horizontal position.

Note: If the thread spool is too large to be in horizontal position, wind the bobbin as described under "Winding Specialty Threads" below.

3. Bring the thread up from the needle, under the presser foot and up to the right through thread guide (A).

Note: Use a metal presser foot when bobbin winding from the needle.

4. Guide the thread through the hole in the bobbin from the inside to the outside.

Note: When using earlier version of HUSQVARNA VIKING® bobbins that do not have a hole, wind a few turns of thread clockwise on the bobbin to get started.

5. Push the bobbin winding lever towards the bobbin to wind. A pop-up message appears on screen. To adjust winding speed drag the slider with your stylus. Stop and start the bobbin winding with the on-screen buttons. Hold the end of the thread firmly when starting to wind. Once the bobbin begins to wind, cut the excess thread.

Note: It is important that you cut the thread end close to the bobbin.

When the bobbin is full, the bobbin winder lever will move back and the winding will stop automatically. The pop-up message closes. Remove the bobbin and cut the thread using the bobbin winding thread cutter.

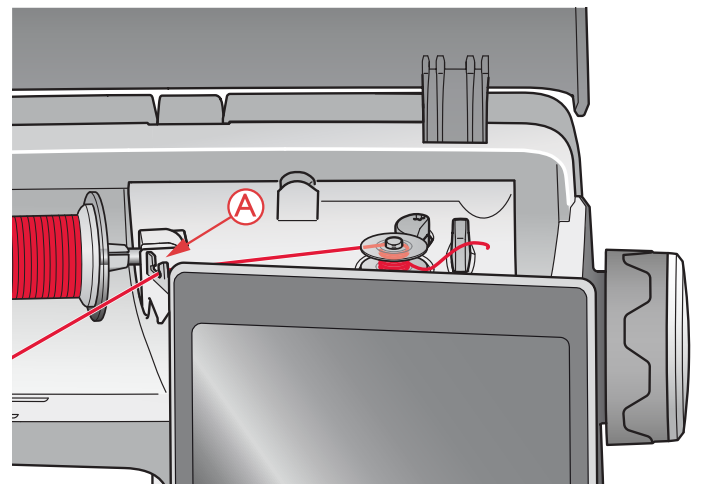
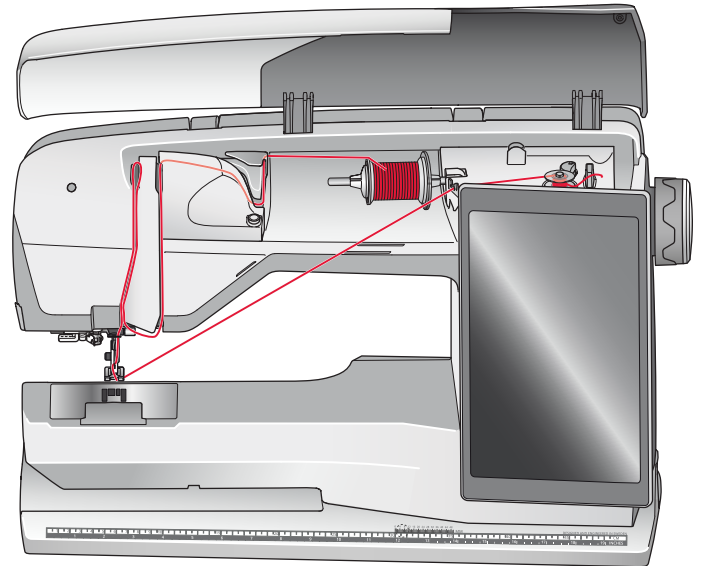

Winding Specialty Threads

We do not recommend winding speciality threads such as “invisible” or other stretchy threads, metallic or flat metallic threads through the needle.

Always wind these threads at minimum speed.

1. Place an empty bobbin on the bobbin spindle at the front of the machine. The bobbin only fits on one way, with the logo facing up. Use only original HUSQVARNA VIKING® bobbins.
2. Place the large spool cap and a felt pad under the spool on the main spool pin set in the vertical position.
3. Bring the thread over the Pre-Tension Thread guide (B) and down around the thread tension disc (C), then through thread guide (D) as illustrated.
4. See Bobbin Winding through the needle, step 4-5.

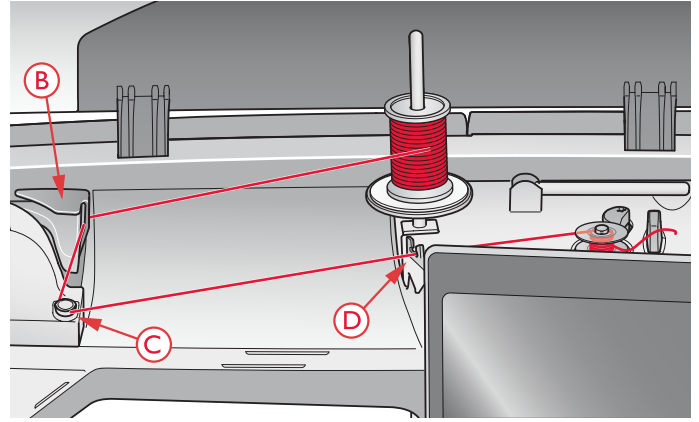

Bobbin Winding while embroidering or sewing

1. Raise the auxiliary spool pin. Place the large spool cap, felt pad and thread spool on the spool pin.
2. Bring the bobbin thread around the thread tension disc (A) and through the thread guide (B) as illustrated.
3. Guide the thread through the hole in the bobbin from the inside to the outside.
4. Push the bobbin winder lever towards the bobbin to wind. A pop-up message appears on screen. To adjust winding speed drag the slider with your stylus. Stop and start the bobbin winding with the on-screen buttons. Hold the end of the thread firmly when starting to wind.

When the bobbin is full, the bobbin winder lever will move back and the winding will stop automatically. The pop-up message closes. Remove the bobbin and cut the thread using the bobbin winding thread cutter.

Note: Make sure that the thread does not touch the cap of the horizontal spool pin when winding the bobbin. If it does, place the cap and spool higher on the vertical spool pin.

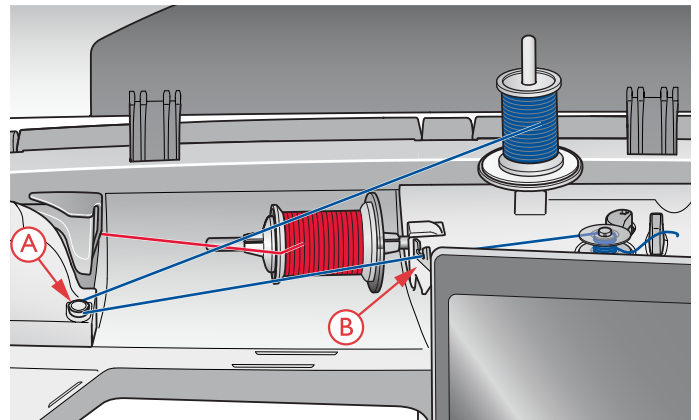

Inserting the Bobbin



Use only the bobbins designed for your DESIGNER BRILLIANCE™ 80 machine.

1. Remove the bobbin cover by sliding it towards you.
2. Place the bobbin in the bobbin case. It drops in only one way with the logo facing up. The thread unreels from the left of the bobbin. The bobbin will then rotate counter-clockwise when you pull the thread.
3. Place your finger on the bobbin to keep it from turning as you pull the thread firmly to the right and then to the left into the tension spring (A) until it “clicks” into place. Continue threading around (B) and to the right of the thread cutter (C).
4. Slide on the bobbin cover (D). Pull the thread to the left to cut (E).

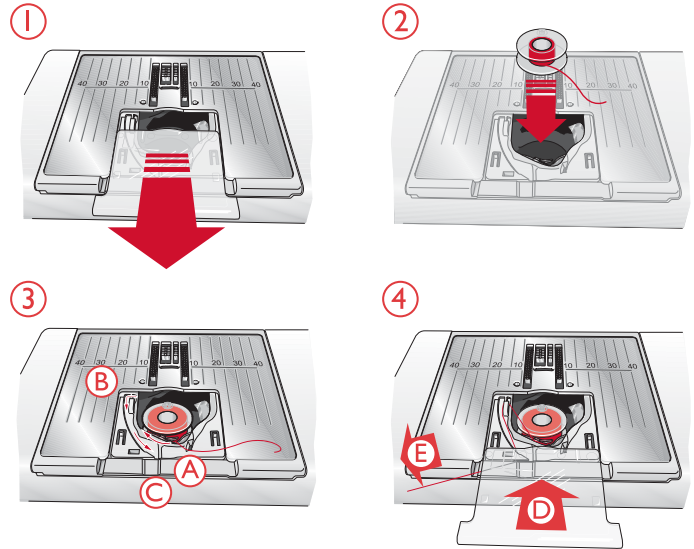

Changing the Presser Foot

1. Make sure that the needle is in the highest position. Pull the presser foot down and towards you.
2. Line up the cross pin on the foot with the gap in the presser foot ankle. Push the foot into the gap until the foot snaps into place.

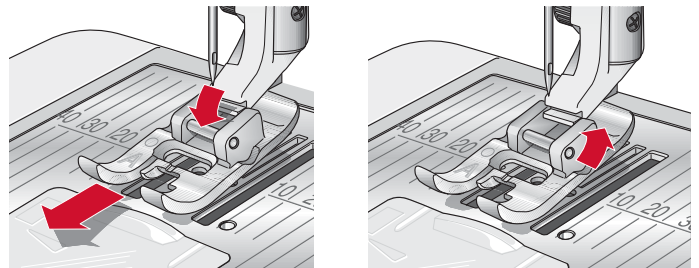

Attaching the Sensor One-Step Buttonhole Foot

1. Snap on the Sensor One-Step Buttonhole Foot.
2. Insert the plug, with the three dots facing out, into the accessory socket at the back of the sewing head.

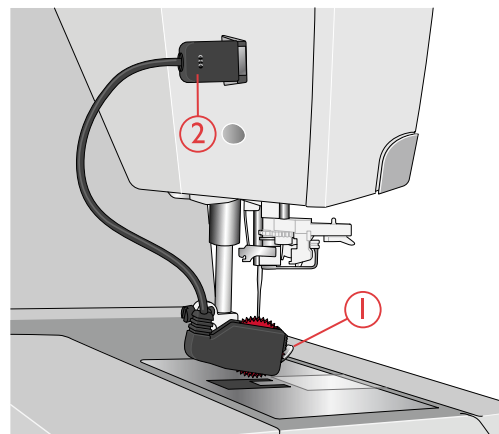

Attaching the Sensor Q-Foot

1. Using the screwdriver, remove the presser foot ankle.
2. Place the Sensor Q-foot from behind, and lower the needle into the opening of the foot by turning the handwheel towards you.

Position the foot onto the presser foot bar so that the hole on the foot matches the hole on the presser foot bar. The arm of the presser foot should rest on top of the needle screw. Insert the screw and tighten the screw with a screwdriver.

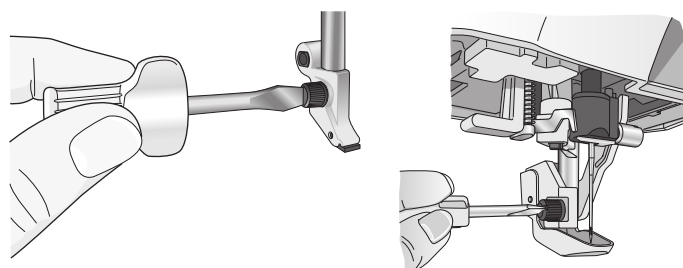

Dual Feed With Changeable Presser Feet

The Dual Feed Foot with changeable presser feet is designed to feed layers of fabric and/or batting evenly. It is perfect for quilting, sewing velvet, stretch fabrics, imitation leathers and fabrics that need precise pattern matching. Snap on the Changeable Straight Stitch Foot when using the straight stitch in the center needle position with a stitch length up to 6mm. Snap on the Changeable Zigzag Foot when selecting stitches up to 7mm wide and 6mm long.

1. Dual Feed
2. Changeable Zigzag Foot
3. Changeable Straight Stitch Foot

Note: Look for optional dual feed accessories in the online accessory user's guide at www.husqvarnaviking.com or at your HUSQVARNA VIKING® retailer.

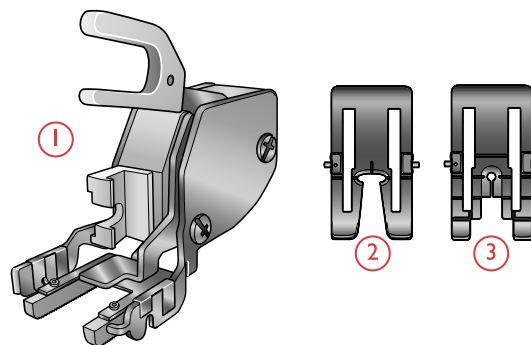

Attaching the Dual Feed

1. Use the screwdriver to remove the presser foot ankle.
2. Place the dual feed on your machine from the back, positioning the fork over the needle clamp screw. Then screw the dual feed onto the presser foot bar with the presser foot ankle screw.

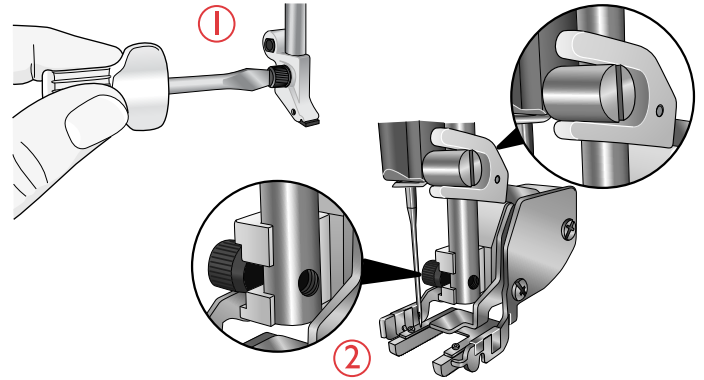

Snap on and Remove the Presser Foot

3. With presser foot bar in the up position, place the presser foot under the dual feed.
4. Push the foot upwards so that it snaps into place.
5. To remove the foot, push the front of the foot upwards until the foot snaps off.

Note: Always keep the dual feed with a foot snapped-on when it is not attached to the machine.

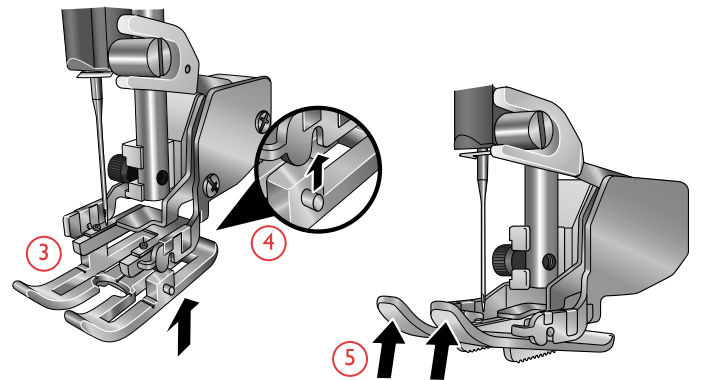

How to Attach the Guide

The two edge/quilting guides included with your machine will help you sew parallel rows of stitching side by side as in channel quilting or tucking. There is one guide for the left side, and one for the right.

6. Insert the guide into the hole in the back of the dual feed. Adjust the space between the foot and the guide by pulling it to the left or to the right.

Note: The edge guides can also be used without the dual feed. Insert one into the hole at the back of the presser foot ankle and tighten the screw.

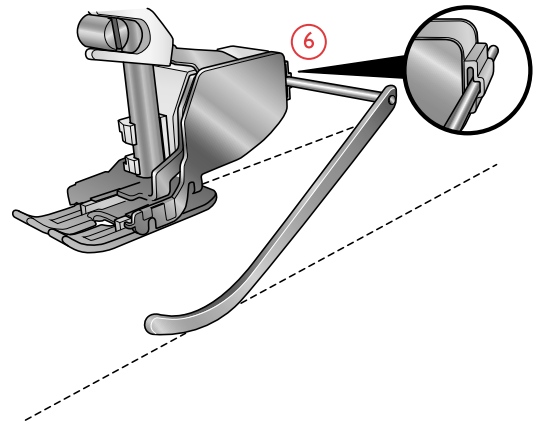

Changing to Straight Stitch Plate

The Straight Stitch Plate is recommended for embroidery. It may also be used for certain techniques in sewing mode, such as quilt piecing. The smaller hole in the Straight Stitch Plate supports the fabric closer to the needle and helps prevent the fabric from being pulled down into the bobbin area, especially at the beginning and/or end of a seam.

1. Remove the presser foot and slide off the bobbin cover.
2. Make sure that the feed teeth are lowered. Place the screwdriver under the needle plate as shown in the picture and gently turn the screwdriver to pop off the needle plate.

Note: Lower the feed teeth by touching the presser foot up and extra lift button.

Note: When changing the needle plate, clean any lint and threads from the bobbin area.

3. With feed teeth lowered, place the straight stitch plate so that it fits into the notch at the back (A). Press the straight stitch plate down until it clicks into place. Slide on bobbin cover.



To prevent needle breakage or damage to the plate, remove any accessory that is not compatible with the Straight Stitch Plate, such as twin needle.

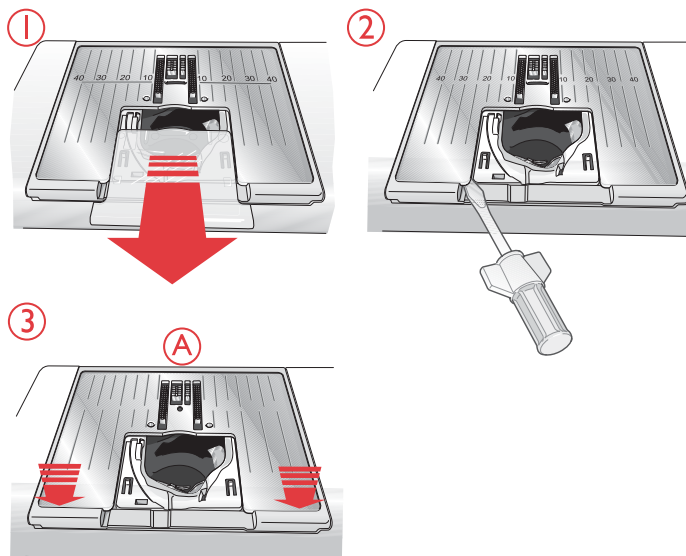





3 Embroidery Preparations

Embroidery Unit

(type BE 17)

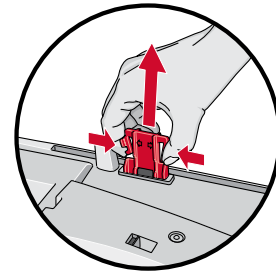
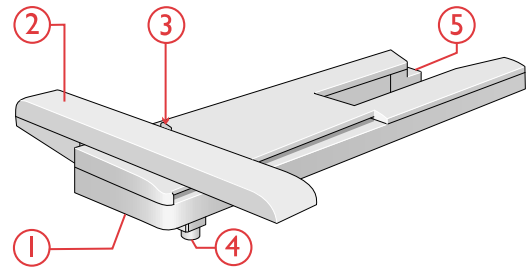
1. Embroidery unit release button (underside)
2. Embroidery arm
3. Embroidery hoop attachment
4. Level adjustment feet
5. Embroidery unit plug



 *When removing the embroidery unit from the box for the first time, be sure to remove the shipping brace on the underside of the embroidery unit.*

Embroidery Hoop Overview

1. Embroidery hoop connector
2. Outer hoop
3. Inner hoop
4. Quick release
5. Retaining screw
6. Ribs for fitting the clips
7. Center marks

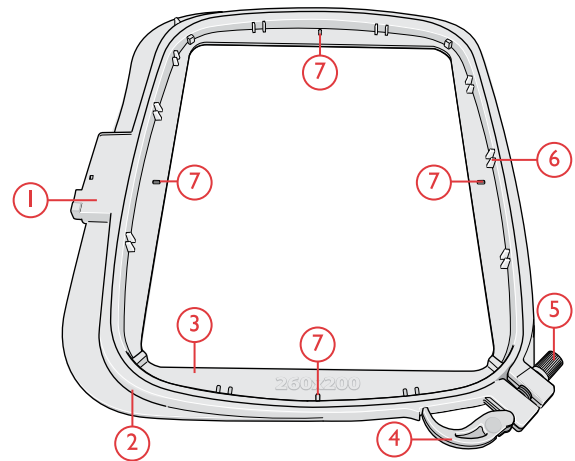

Sensor Q-Foot

The Sensor Q-foot is recommended for hoop embroidery.

See Attaching the Sensor Q-Foot, page 38.

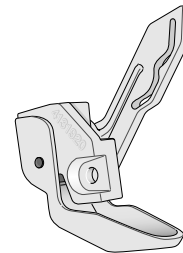

Straight Stitch Plate

The Straight Stitch Plate is recommended for hoop embroidery.

See Changing to Straight Stitch Plate, page 40.

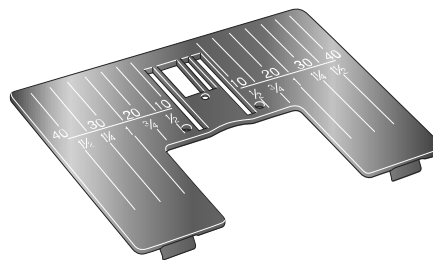

Designs

Over 570 designs are included in the machine memory. These designs, along with the eight built-in embroidery fonts, are shown in the DESIGNER BRILLIANCE™ 80 sampler book.

DESIGNER BRILLIANCE™ 80 Sampler Book

Page through the DESIGNER BRILLIANCE™ 80 sampler book for designs and fonts.

All included designs are pictured and the design number is shown. For designs with special embroidery techniques information about stitch count (number of stitches in the design) and the design size is also shown, as well as the complete color block list including information about the technique blocks.

Connect the Embroidery Unit

1. Slide the accessory tray off.
2. Slide the embroidery unit onto the free arm of the machine until it plugs firmly into the socket at the back of the machine. If needed, use the level adjusting feet so that the machine and embroidery unit are even. If the machine is turned off, turn it on.
3. If you were already in embroidery mode or when you switch to embroidery mode, a pop-up message tells you to clear the embroidery arm and remove the hoop before calibration. Touch OK. The machine will calibrate and the embroidery arm will move to the ready position.

Note: DO NOT calibrate the machine with the embroidery hoop attached as this can damage the needle, presser foot, hoop and/or the embroidery unit. Be sure to clear all materials from around the machine before calibrating so that the embroidery arm does not bump into anything while calibrating.

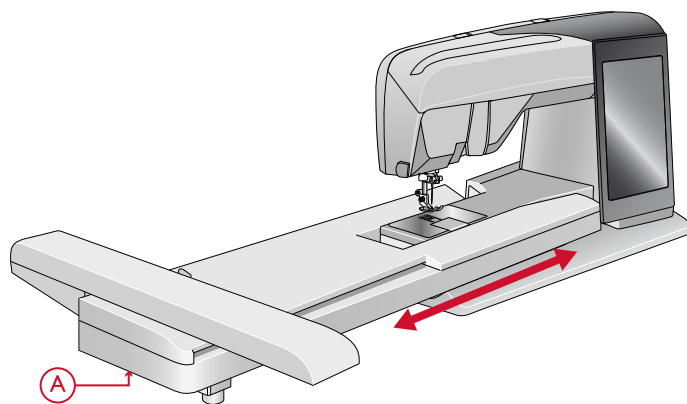
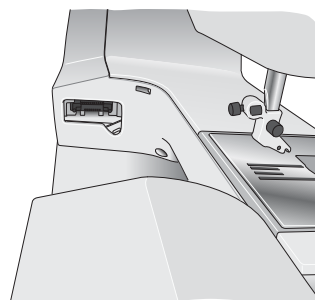

Remove the Embroidery Unit

1. To store the embroidery unit in the embroidery case, move the embroidery arm to park position. See park position .
2. Press the button at the left, underneath the embroidery unit (A) and slide the unit to the left to remove it.
3. Store the embroidery unit in the original black styrofoam packing material, placed in the soft carrying bag.

To Hoop the Fabric

For the best embroidery results, place a layer of stabilizer beneath the fabric. When hooping stabilizer and fabric make sure that they are smooth and securely hooped.

1. Open the quick release (A) on the outer hoop and loosen the screw (B). Remove the inner hoop. Place the outer hoop on a firm flat surface with the screw on the lower right (B). There is a small arrow in the center of the lower edge of the hoop which will line up with a small arrow on the inner hoop.
2. Place the stabilizer and fabric, with the right sides facing up, on top of the outer hoop. Place the inner hoop on top of the fabric with the small arrow at the bottom edge. If you can see the hoop size in the lower part of the inner hoop, you have attached it correctly.
3. Push the inner hoop firmly into the outer hoop.
4. Close the quick release (A). Adjust the pressure of the outer hoop by turning the retaining screw (B). The fabric should be taut in the hoop for the best results.

Note: When embroidering additional designs on the same fabric, open the quick release, move the hoop to the new position on the fabric and close the quick release. When changing type of fabric, you might need to adjust the pressure using the retaining screw. Do not force the quick release.

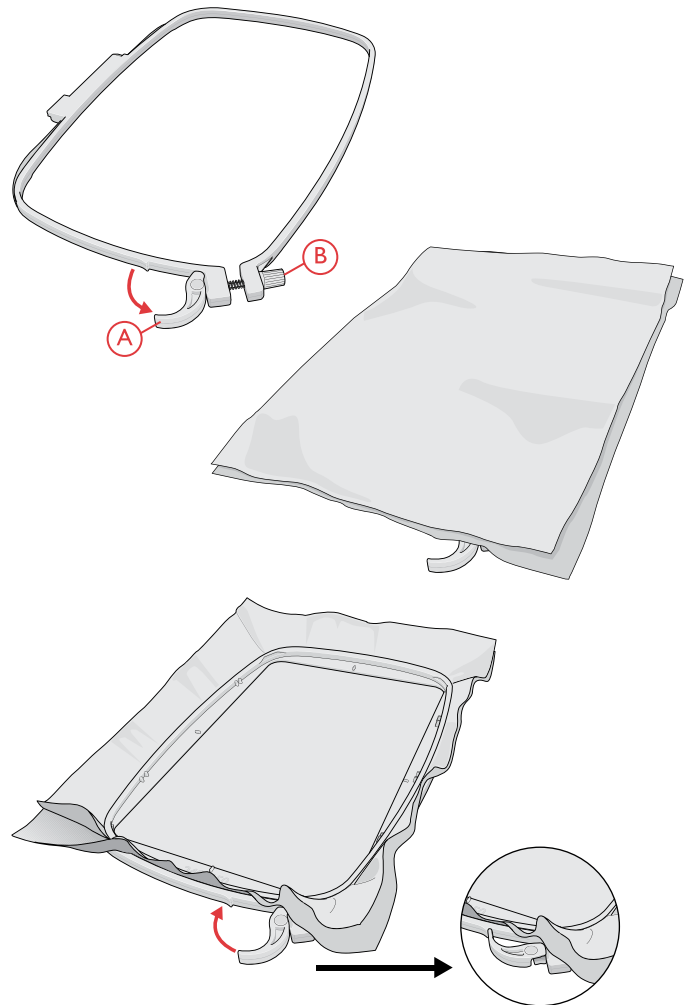

Slide on/off the Hoop

Slide the hoop connector into the hoop attachment (A) from front to back until it clicks into place.

To remove the hoop from the embroidery arm, press the grey button (B) on the hoop attachment and slide the hoop towards you.

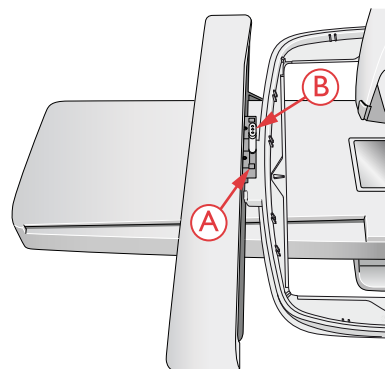

4 The Multi-Touch Screen

Multi-Touch Screen

Your DESIGNER BRILLIANCE™ 80 machine features a multi-touch screen which is very easy to use. A few simple gestures – touch, touch & hold, pinch/stretch, touch and move and swipe – are all you need to use the multi-touch screen.

Gestures

Touch

Touch once and release on the screen to select your choices e.g. in settings or on a design.

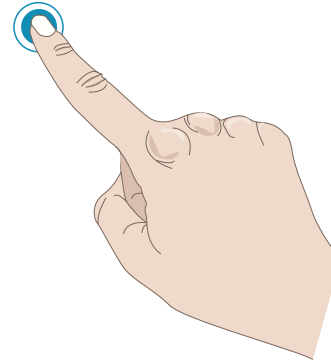

Touch & Hold

Touch once without releasing for a few seconds to touch & hold e.g. on a stitch program or a design to open the smart toolbox.

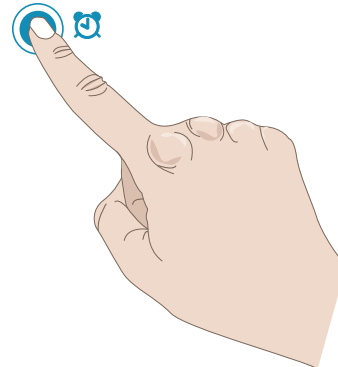

Pinch/Stretch

Touch with two fingers at the same time and without releasing reduce the distance between the fingers to pinch e.g. to zoom out. Touch with two fingers at the same time and without releasing increase the distance between the fingers to stretch e.g. to zoom in.

This function is very useful in stitch menu and design menu to zoom in and out over stitches and designs. It is also useful when reading your user's guide to zoom in texts and pictures.

Note: If you pinch/ stretch on a selected design this will activate the position function and you will move the design instead of zooming the embroidery area.

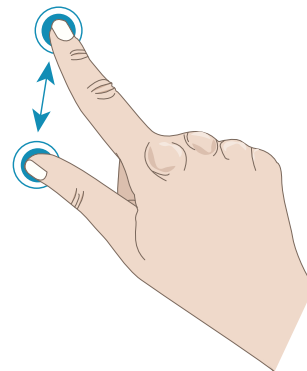

Touch and Move

Touch once and without releasing move your finger to a different position on the screen to touch and move e.g. for moving a selected design in the embroidery area.

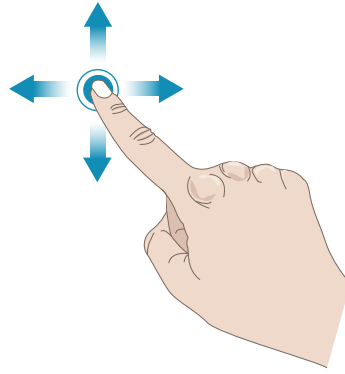

Swipe

Touch your finger in a continuously left to right or right to left moving gesture to swipe horizontally e.g. over the stitch menu to scroll between the stitch menus.

Touch your finger in a continuously top to bottom or bottom to top moving gesture to swipe vertically e.g. over the stitch menu to scroll within a stitch menu.

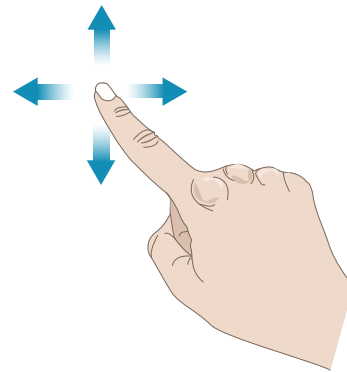

Smart Toolbox

Smart toolbox is available on a stitch or program in the sewing area or on a design, stitch or program in the embroidery area. Touch & hold on a stitch program or design to open the smart toolbox, move your finger to highlight the option you want to use and release to select the option.

The options included in the smart toolbox varies depending on where and on what it is used. Examples of options are duplicate, delete, mirroring and edit.

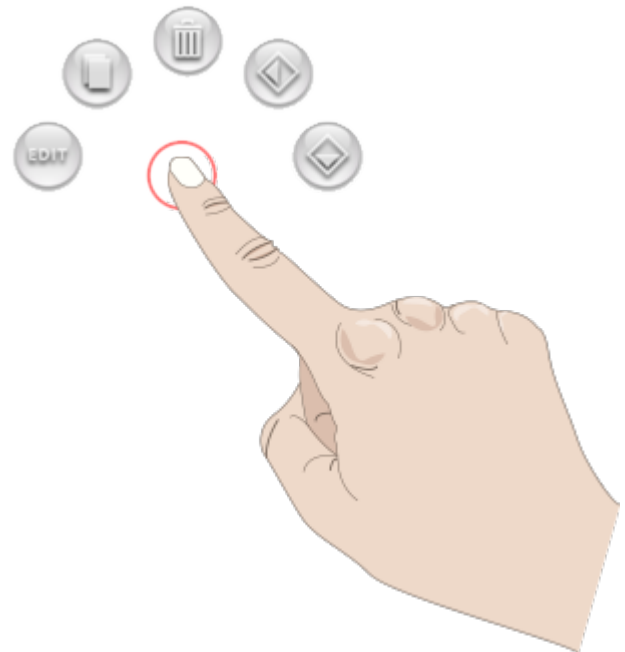

Common Functions

The following functions on the screen are used frequently.

OK

Confirms changes and pop-up messages and returns to previous window.



Cancel

Cancels changes and pop-up messages and returns to previous window.



Embroidery Edit

In the lower right corner of the embroidery edit window, there is a GO button. Touch the button to enter welcome to embroidery stitch out window.



Embroidery Stitch Out

Touch the return button in the lower right corner of the embroidery stitch out window to return to embroidery edit.



Touch & Hold

Some buttons have additional functions, marked with an arrow at the lower right corner. To access those functions, touch & hold on the button for a few seconds.



Topbar

On the topbar you will find the following functions: WiFi, *mySewnet*[™] button, firmware update, JoyOS *advisor*[™] button, quick help, settings and sewing/embroidery mode toggle.

Note: All functions may not always be available at the same time.



1. WiFi
2. *mySewnet*[™]
3. Wireless firmware update
4. JoyOS *advisor*[™] feature
5. Quick help
6. Settings
7. Sewing/embroidery mode toggle

WiFi

Touch the WiFi button in the topbar and activate WiFi. Select a network from the list of available networks. If your network is password protected, you will be prompted to enter the password in the pop-up.

You can also connect to a network with WiFi in settings.

If you do not get any signal or have a low signal strength see troubleshooting.

	WiFi is connected with high signal strength.
	WiFi is connected with medium signal strength.
	WiFi is connected with low signal strength.
	WiFi is connected but the network does not work properly.
	WiFi is disconnected. Connect to a network through the WiFi button or WiFi settings.

Read more about WiFi in the machine in the WiFi chapter.

mySewnet™





Touch the *mySewnet*™ button on the topbar and touch sign in button to open a pop-up. Sign in to your *mySewnet*™ account or create a new *mySewnet*™ account.

When signed in you will see how much available space there is left in the *mySewnet*™ cloud.

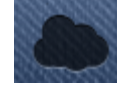
The synchronization status will be shown on the *mySewnet*™ button on the topbar:

If your machine cannot connect to *mySewnet*™ cloud or does not synchronize, see troubleshooting.



	All files in the machine and <i>mySewnet</i> ™ cloud are synchronized.
	The machine is currently synchronizing files with the <i>mySewnet</i> ™ cloud.
	The <i>mySewnet</i> ™ cloud cannot synchronize with your machine. Check if you have available space on the <i>mySewnet</i> ™ cloud.
	Signed in to your <i>mySewnet</i> ™ account but the machine has no WiFi connection. Connect the machine to a WiFi network.
	Not signed in to your <i>mySewnet</i> ™ account. Log in or create a <i>mySewnet</i> ™ account to be able to synchronize files from the machine to the <i>mySewnet</i> ™ cloud.

Read more about *mySewnet*™ cloud in the *mySewnet*™ chapter.

Wireless Firmware Update

Your DESIGNER BRILLIANCE™ 80 is a modern, updateable sewing and embroidery machine. It is always recommended to install the latest firmware in your machine. Firmware updates will always be to the benefit of the user and the product.

To be able to get the latest firmware you need to connect to a network using WiFi or update through a USB device. When connected, your machine will automatically search for available firmware update. Touch the firmware update button on the topbar to download and install the latest firmware.

Read more about wireless firmware update in the section firmware update using WiFi.



JoyOS advisor™ feature

Touch the JoyOS *advisor*™ feature button to automatically open the JoyOS *advisor*™ feature. Read about the JoyOS *advisor*™ feature.



Quick Help

Touch quick help on the topbar. The button becomes highlighted and flashes indicating that quick help is active. Touch an icon, button or an area on the screen you want information about. A pop-up will appear giving you a short text about the icon, button or area. Touch OK to close the pop-up and exit quick help.



Some quick helps will refer to the built-in user's guide for more information. This will be shown with a blue button. Touch the button to open the built-in user's guide.

Settings

Touch settings button to open the settings window. Read about settings in the machine.

If a sewing or embroidery technique is loaded from the JoyOS *advisor*TM feature some settings that are recommended will automatically be set when loading stitches and/or designs from the JoyOS *advisor*TM project menu. This will be indicated with an exclamation mark on the settings button. Touch the button to open settings and see which setting(s) has been changed.



Settings button in sewing mode

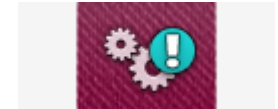

Settings button in embroidery mode

Sewing/Embroidery Mode Toggle

Toggle between sewing and embroidery mode by touching the sewing/embroidery mode toggle in the upper right corner.





5 WiFi & *mySewnet*[™] Services

WiFi Introduction

Your DESIGNER BRILLIANCE™ 80 machine features WiFi which makes it possible to connect your machine wireless to the *mySewnet*™ services.

Getting Started With WiFi





Touch the WiFi button in the topbar and activate WiFi. Select a network from the list of available networks. If your network is password protected, you will be prompted to enter the password in the pop-up to be able to connect.



Touch the “i” button to the right to open a information pop-up about the network. You can also see the signal strength and if the network is password protected, indicated with a closed padlock.

You can also connect to a network with WiFi in WiFi settings.

If you do not get any signal or have a low signal strength see troubleshooting.

	WiFi is connected with high signal strength.
	WiFi is connected with medium signal strength.
	WiFi is connected with low signal strength.
	WiFi is connected but the network does not work properly.
	WiFi is disconnected. Connect to a network through WiFi button or WiFi settings.

Hidden Network

Touch the button to connect to a hidden network. A pop-up will be shown on the screen where you can enter the name of the hidden network.

Firmware Update Using WiFi

Your DESIGNER BRILLIANCE™ 80 is a modern, updateable sewing and embroidery machine. It is always recommended to install the latest firmware in your machine. Firmware updates will always be to the benefit of the user and the product.

To be able to wireless get the latest firmware you need to connect to a network using WiFi. When connected, your machine will automatically search for available firmware update. If the machine has detected that there is a newer firmware available, the firmware update button will be visible on the topbar. Touch the button to open a pop-up to download and install the latest firmware.

When the update is completed the machine will restart automatically. Check the firmware version number in settings, machine information.



Firmware update button on the topbar

	Indication that your machine does not have the latest firmware. Touch the button to open a pop-up to download and install the latest firmware.
	A spinning wheel will be shown on the firmware update button indicating that the firmware is downloading.
	An exclamation mark will be shown on the firmware update button to notify that there is a downloaded firmware waiting to be installed.

Firmware Update Using a USB Device

Visit the HUSQVARNA VIKING® website from your PC at www.husqvarnaviking.com and find your machine. Here you will find the available updates.

You can also login to the *mySewnet*™ portal to find the firmware update.

1. Download the update firmware zip file. Unzip the file and copy the file (.clo) to a USB device.

Note: Do not change the name of the file or do not copy the file into an existing folder on the USB device.

Note: Make sure that there is no old firmware update file (.clo) on the USB stick when copying the new firmware update file (.clo). The file name is not unique.

2. Make sure that the machine is turned off. Connect the USB device loaded with the new firmware version to a USB port on your machine.
3. Press and hold the reverse button, located on the right side of the sewing head, and turn on your machine with the ON/OFF switch. Release the reverse button when an update icon is shown on the screen.
4. The firmware update will be verified and installed. The machine may restart several times during the update process. Do not turn off the machine.
5. When the update is completed the machine will restart automatically. Check the software version number in settings, machine information.

Complimentary Software (PC)

A PC software package is available for your DESIGNER BRILLIANCE™ 80 machine. It adds the following features:

- The *mySewnet*™ cloud sync tool allows you to synchronize your content in the *mySewnet*™ cloud and your sewing machine with a folder on your PC. Drag and drop files to the folder on your PC and the files will automatically be transferred to the *mySewnet*™ cloud and accessible from your machine when signed in to the *mySewnet*™ account.

For PC and MAC computers

PREMIER+™ 2 Free - Complimentary Machine Support

For Windows® 10, Windows® 8 and Windows® 7 (English, French, German and Italian)

For Mac OS X - El Capitan®, Sierra®, and High Sierra® (English only)

- This complimentary software allows you to open the PREMIER+™ 2 Embroidery module in Free mode. You can open embroidery stitch files, Flip, Rotate, Combine, ColorSort, change thread colors, print templates, and Export to other stitch formats.
- There is no activation code or installation code used with PREMIER+™ 2 Free.
- PREMIER+™ 2 QuickFont - Create font files (.VF3) for your embroidery machine from most TrueType® or OpenType® fonts on your computer.
- PREMIER+™ 2 Explorer Plug-In - View embroideries as thumbnail images in Windows® Explorer.

Search for and sort your embroideries with ease. Browse them in different sizes and print a worksheet.

Convert your designs to other embroidery formats, add trim commands or change thread range.

Visit the HUSQVARNA VIKING® website at www.husqvarnaviking.com to get support. Select your machine model and download the software. You can also find the complimentary software at the *mySewnet*™ portal.

More information and detailed installation instructions are available on the download page.

mySewnet™ Services

Your DESIGNER BRILLIANCE™ 80 machine features the *mySewnet™* services which contains the following:

- *mySewnet™* account – A personal login-based account to access the different *mySewnet™* services.
- *mySewnet™* cloud – A cloud based service where you will save and access your personal files from three different places: the *mySewnet™* cloud folder on the machine, the *mySewnet™* cloud sync tool on your PC and the *mySewnet™* portal. From the *mySewnet™* cloud you will be able to view current machine and embroidery status through the mySewMonitor app.
- *mySewnet™* portal – A website with different *mySewnet™* services such as register machines, edit personal user profile and manage files in the *mySewnet™* cloud.

mySewnet™ Account

Start with register a *mySewnet™* account to be able to use the *mySewnet™* services. You can create your account from *mySewnet™* button on the topbar or in *mySewnet™* settings.

Touch the sign in button and a pop-up will be opened where you can choose to register a new *mySewnet™* account.

A *mySewnet™* account can also be created through the *mySewnet™* portal at husqvarnaviking.mysewnet.com.



mySewnet™ Cloud

The *mySewnet*™ cloud is a service for hosting files in the “cloud” that is available to all owners and users of a *mySewnet*™ cloud featured machine such as your DESIGNER BRILLIANCE™ 80 machine. The *mySewnet*™ cloud offers a simple way to manage and access personal files from three different places: the *mySewnet*™ cloud folder on the machine, the *mySewnet*™ cloud sync tool on your PC and the *mySewnet*™ portal.

- *mySewnet*™ cloud folder on the DESIGNER BRILLIANCE™ 80 machine – In file manager you find the *mySewnet*™ cloud folder where you store and synchronize your files to the *mySewnet*™ cloud.
- *mySewnet*™ cloud sync tool on your PC – Install the *mySewnet*™ cloud sync tool on your PC to keep a local folder on your PC synchronized with the *mySewnet*™ cloud.
- *mySewnet*™ portal – Manage the files in the *mySewnet*™ cloud through an ordinary web browser.

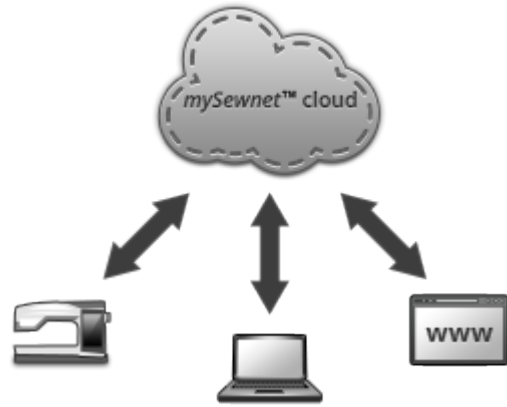

The synchronization status will be shown on the *mySewnet*™ button in the topbar:

	All files in the machine and <i>mySewnet</i> ™ cloud are synchronized.
	The machine is currently synchronizing files with the <i>mySewnet</i> ™ cloud.
	The <i>mySewnet</i> ™ cloud cannot synchronize with your machine. Check if you have available space on the <i>mySewnet</i> ™ cloud.
	Signed in to your <i>mySewnet</i> ™ account but there is no connection to the <i>mySewnet</i> ™ server.
	Not signed in to your <i>mySewnet</i> ™ account. Log in or register a <i>mySewnet</i> ™ account to be able to synchronize files from the machine to the <i>mySewnet</i> ™ cloud.

If your machine cannot connect to *mySewnet*™ cloud or does not synchronize, see troubleshooting.

Used Space in *mySewnet*™ Cloud

The *mySewnet*™ cloud will store designs, fonts, stitches and other files from your machine.

Touch the *mySewnet*™ button on the topbar or go to *mySewnet*™ settings. When only a small amount of space is left, your machine will alert you once. If you continue to fill the space, it will not remind you again, until the space is completely full. Delete or move files to a USB device to free space.

*Note: The *mySewnet*™ cloud space gets activated the first time you sign in on your *mySewnet*™ account from the machine.*







Installation of mySewnet™ Cloud Sync Tool for PC

Install the *mySewnet*™ cloud sync tool to support synchronization of a local folder on your PC with the content stored in *mySewnet*™ cloud. The installation requires one of the following PC platforms: Windows® 7, Windows® 8 or Windows® 10.

Installation Instructions

1. Download the synchronization tool to your PC from the *mySewnet*™ portal at husqvarnaviking.mysewnet.com.
2. On your PC, double click on the file *mySewnetCloudSyncSetup.exe* to run the setup wizard. Go through the steps in the setup wizard to install.
3. Once it is installed, you will see a *mySewnet*™ cloud sync folder on your hard drive. Add, modify or delete content in your *mySewnet*™ folder on your PC in order to add, modify or delete content in the *mySewnet*™ cloud folder on your DESIGNER BRILLIANCE™ 80 machine.

The synchronization status will be shown on the *mySewnet*™ button on the taskbar:

	Signed in to <i>mySewnet</i> ™ cloud.
	Synchronizing files with the <i>mySewnet</i> ™ cloud.
	Not signed in to the <i>mySewnet</i> ™ cloud sync tool.
	Cannot synchronize with the <i>mySewnet</i> ™ cloud sync tool. Check the used space in the <i>mySewnet</i> ™ cloud.

Synchronize a File

Make sure that you are signed in to *mySewnet*™ account on your machine. Also make sure that the *mySewnet*™ cloud sync tool is installed and running on your PC.

1. Drag and drop the file into the *mySewnet*™ cloud folder on your PC.

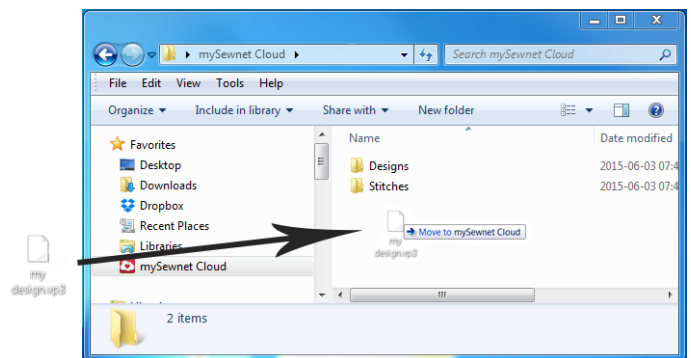

2. The icon is shown as long as the synchronization is progressing.



3. The icon means that your file has finished synchronizing and is now available from *mySewnet*TM cloud folder in file manager on your DESIGNER BRILLIANCETM 80 machine and also in *mySewnet*TM portal.



mySewnetTM Portal

The *mySewnet*TM portal is a personal web page with access to the different *mySewnet*TM services. Login to the *mySewnet*TM portal with your *mySewnet*TM account. You can access the *mySewnet*TM portal at husqvarnaviking.mysewnet.com to use the following services:

- My machines – Overview of your machines' related material such as user's guide, sewing project inspiration, optional accessories information etc.
- My profile – Overview of your personal profile, with contact information, e-mail subscriptions, interest information and account details etc.
- *mySewnet*TM cloud – Possibility to manage your personal files. The files are automatically synchronized with the *mySewnet*TM cloud folder in the DESIGNER BRILLIANCETM 80 machine and the *mySewnet*TM cloud sync tool.

mySewMonitor App

With the mySewMonitor app in your mobile device your DESIGNER BRILLIANCETM 80 machine can send messages to you when it needs attention. Download the mySewMonitor app to your mobile device at App Store or Google Play. You can also download the app via the *mySewnet*TM portal at husqvarnaviking.mysewnet.com.

The app will display current embroidery status:

- All color blocks in loaded design(s).
- Current stitch number and current color block
- Machine pop-up messages such as thread color change and bobbin thread low.





6 JoyOS *advisor*[™]

JoyOS *advisor*™ Introduction

The JoyOS *advisor*™ feature contains a SEWING ADVISOR™, EMBROIDERY ADVISOR™, QUILT ADVISOR, a Knowledge Center and a built-in user's guide. In the JoyOS *advisor*™ feature you will find interactive instructions of sewing and embroidery techniques and a stabilizer guide.

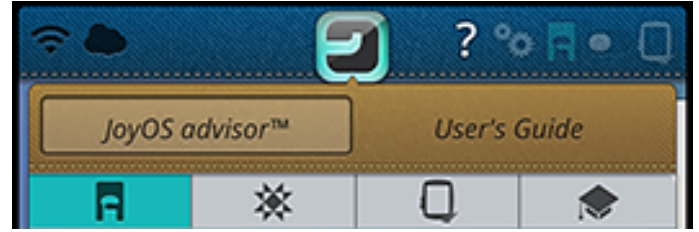

JoyOS *advisor*™ Project Menu

In the JoyOS *advisor*™ project menu recommended stitches and/or designs will be shown for the current loaded sewing/embroidery technique. The button will be selected by default when choosing a technique from the JoyOS *advisor*™ feature.



JoyOS *advisor*™ Project Viewer

When loading a JoyOS *advisor*™ project from the JoyOS *advisor*™ feature it will be shown in the project viewer which is always accessible on the screen. When the project viewer is minimized, touch the button to expand.



JoyOS advisor™ Project Viewer – Overview

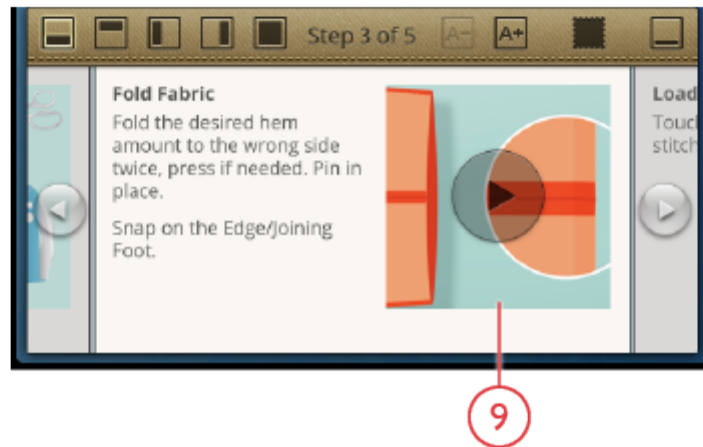
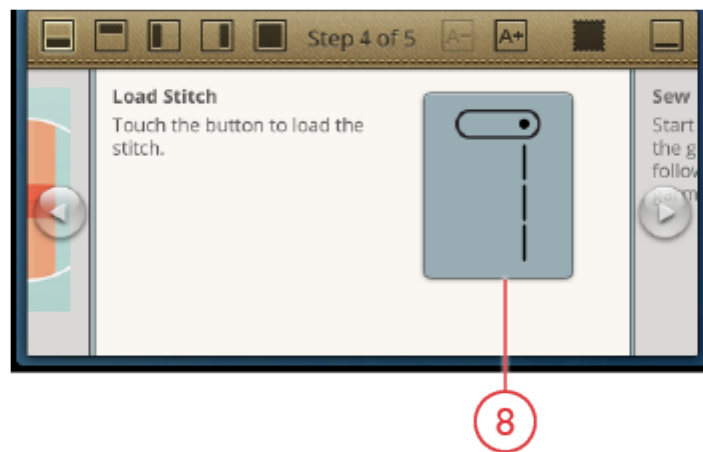

1. Move the viewer on the screen to your personal liking and to be able to reach buttons that are hidden when following the instructions.
2. Decrease or increase the text in the viewer by touching the A- or A+ buttons.
3. Select the fabric that you will use. The stitches loaded through the project are set to fit your selected fabric.
4. To minimize, touch at the top right corner. To expand it again, touch the JoyOS advisor™ project viewer button.
5. Touch the right arrow to step forward in the instruction and touch the left arrow to step backwards.
6. Information shown for each step in the instruction.
7. Every picture can be expanded by touching it in the viewer.
8. Load the recommended stitch for the loaded technique by touching the stitch in the viewer.
9. Animations is shown with a play icon over the picture. Touch the play icon to load the animation. More detailed description in animations.

Pictures in JoyOS *advisor*™ Project Viewer

Pictures in the JoyOS *advisor*™ project viewer can be enlarged by touching them, which is very useful for pictures such as lists of material. Touching a picture of a button will open a guide where to find the button.

Animations in JoyOS *advisor*™ Project Viewer

Animations are shown in the viewer as a picture with a play icon on top. Touch a play button to view the animation. In the video player that opens you can pause, rewind, fast forward, set the animation on repeat and turn full screen mode on/off. Close the animation by touch cancel in the lower right corner. Touch & hold on rewind to start the animation from the beginning.

1. Chapter/Section Icon
2. Rewind (Touch & hold to go to beginning)
3. Play/pause
4. Fast forward
5. Repeat on/off
6. Full screen on/off
7. Close

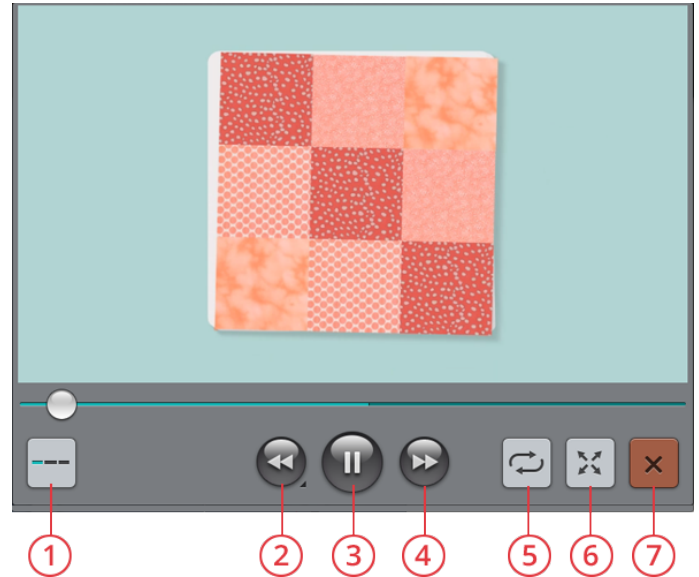

Stitch in JoyOS *advisor*™ Project Viewer

If a certain stitch is recommended in a technique you can load it directly from the viewer by touching the stitch button. The machine will automatically set the best stitch and machine setting.

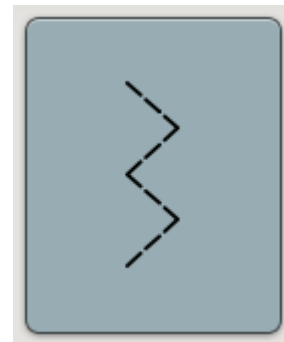

mySewnet™ Blog

Touch this tab to open the *mySewnet*™ Blog where you can view the latest product news, sewing instructions and get inspiration!

A little red envelope icon on top of the tab indicates that news are added since your last visit.

Touch on a post to get more info on that specific project.

The machine needs to be connected to the internet to be able to see the feed.



Search

Touch the search tab and a window will open allowing you to search within the JoyOS advisor™. Enter your search and touch OK. The machine will display the search results.

You can also find the search tab in the User's Guide to enable you to search within the User's Guide.



SEWING ADVISOR™ – Overview

When loading a sewing technique the machine will select the best stitch and settings for your chosen fabric and project.

Depending on which choices you make, your JoyOS *advisor*™ feature will recommend the most suitable sewing techniques.

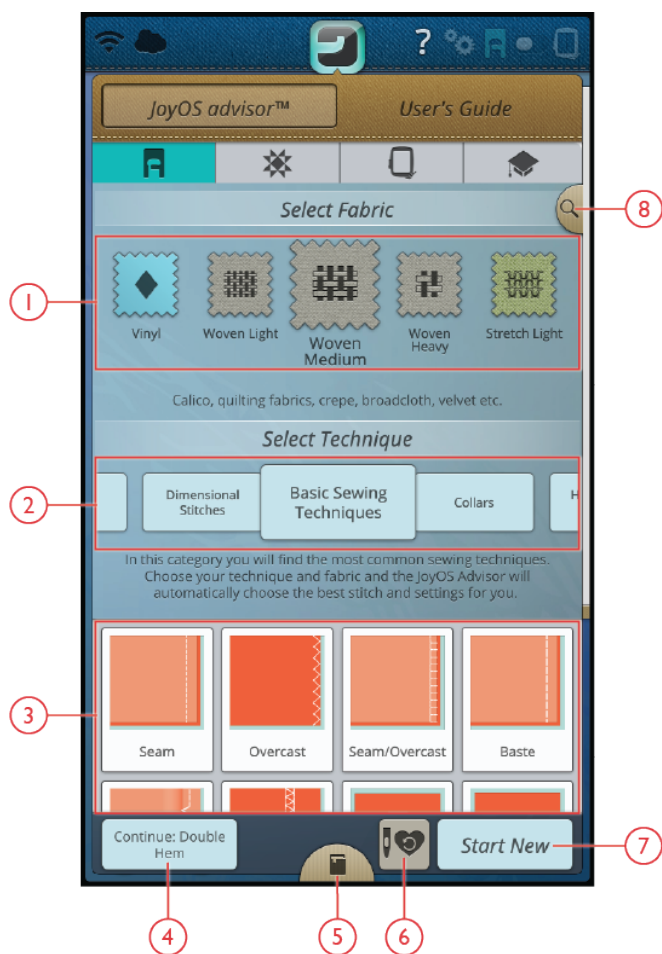

1. Fabric selection
2. Sewing technique groups
3. Sewing techniques

4. Continue with current JoyOS *advisor*™ project
5. JoyOS *advisor*™ project viewer

6. Load smart save
7. Start new
8. Search JoyOS *advisor*™

Fabric Selection

Start your sewing by selecting the fabric that you will use. Suggested fabrics for each fabric group you can choose from are listed below.

Note: Some fabrics have excess dye which can cause discoloration on other fabrics or on your sewing machine. This discoloration may be very difficult or impossible to remove.

Fleece and denim fabric, especially red and blue, often contain excess dye.

If you suspect that your fabric/ ready-to-wear garment contains a lot of excess dye, always pre-wash it before sewing/ embroidering to prevent discoloration of your machine.

Woven or Knit

The difference between woven and knit fabric is the way the threads are put together. Woven fabrics are made of two thread system, warp lengthwise and weft crosswise, that intersect at right angles. A knit fabric is made of one thread system with interlaced stitches. A knit fabric usually has stretch.

As a general rule, select woven in the JoyOS *advisor*TM feature for stable fabrics that have no stretch and stretch for fabric that have stretch.

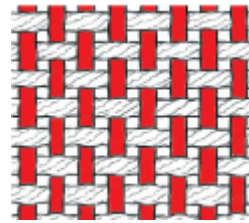

Woven fabric

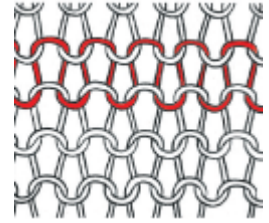

Knit fabric

Woven Fabrics

Woven Light: Chiffon, organza, batiste, challis, crepe de chine etc.

Woven Medium: Calico, quilting fabrics, crepe, broadcloth, velvet etc.

Woven Heavy: Denim, tweed, canvas, terrycloth etc.

Stretch Fabrics

Stretch Light: Tricot, single knit jerseys etc.

Stretch Medium: Sweater knits, double knit, velour, swimwear etc.

Stretch Heavy: Sweater knits, fleece etc.

Leather and Vinyl

For suede and leather. Leather is animal skin with the coat (fur) removed. Leather can be smooth or sueded and has some give.

For vinyl, faux leather and suede. Vinyl is a synthetic material which often has a woven wrong side. Vinyl can be smooth or patterned and some vinyls have stretch.

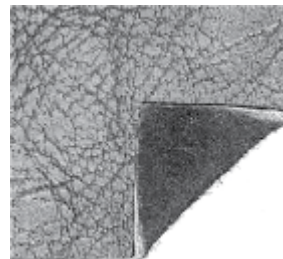

Leather fabric

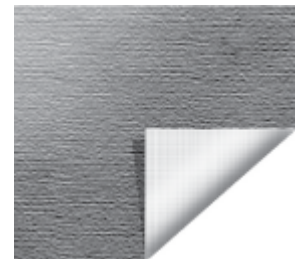

Vinyl fabric

Sewing Technique Groups

After selecting a fabric, touch a sewing technique group and the JoyOS *advisor*TM feature will recommend sewing techniques suitable for your fabric. Touch a sewing technique to load it into the JoyOS *advisor*TM project viewer.

Example: Select woven medium and zippers to show all zipper techniques suitable for woven medium. Change fabric to stretch medium and notice that not all zipper techniques are available since all are not suitable for stretch medium.

Note: Use quick help on a sewing technique for a short description of the technique.

Basic Sewing Techniques

In basic sewing techniques you will find the most commonly used sewing techniques. When you choose one of the basic sewing techniques, the recommended stitch for the chosen fabric is automatically loaded.

Seam

A seam sews two pieces of fabric together with a seam allowance that will usually be pressed open. In most cases, edges of the seam allowance are finished with an overcast stitch before sewing the seam.

Seams in stretch fabric must stretch with the fabric. The stretch stitch makes a stretchy seam that is suitable for sewing together pieces of light stretch fabric.

Your JoyOS *advisor*TM feature will select the best stitch length and stitch width for the fabric weight and recommend the presser foot and needle.

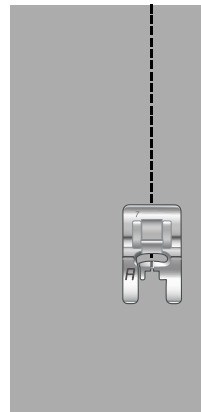

Straight stitch

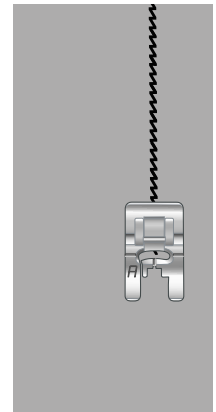

Stretch stitch

Overcast

Overcast fabric edges to prevent fraying and to help them lay flat. It is easier to overcast before the garment is sewn together.

Your JoyOS *advisor*TM feature will select the best stitch length and stitch width for the fabric weight and recommend the presser foot and needle.

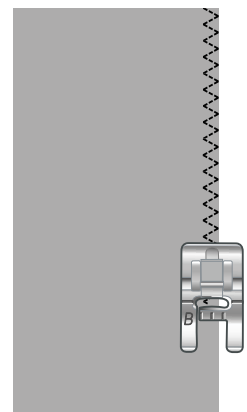
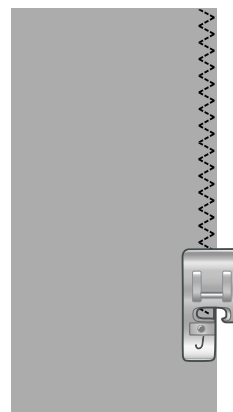

Seam and Overcast

The seam/overcast stitch sews the seam and overcasts the edges all at one time. The seam/overcast technique is perfect for stitching ribbed neckbands and cuffs. There are a number of different seam/overcast stitches in your machine.

Your JoyOS *advisor*TM feature will select the best one for your fabric and make all adjustments automatically and recommend the presser foot and needle.

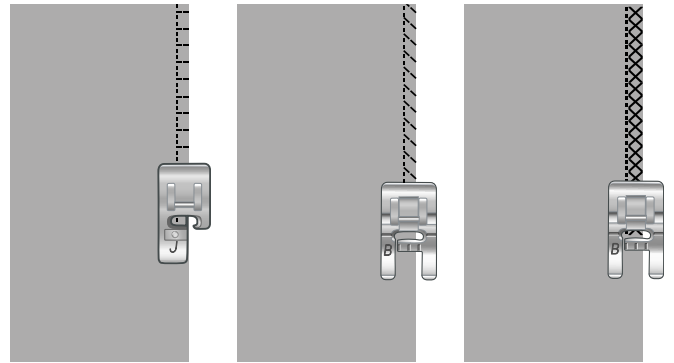

Baste

Basting is temporary stitching for fitting garments, gathering and marking. The JoyOS *advisor*TM feature automatically sets a long stitch length and reduces the tension so the threads are easy to remove or to pull for gathering.



Blind Hem

The blind hem creates an invisible hem on garments. There are two types of blind hem; one is recommended for medium to heavy fabrics, the other for stretch. The blind hem is not suggested for light weight fabric, leather and vinyl.

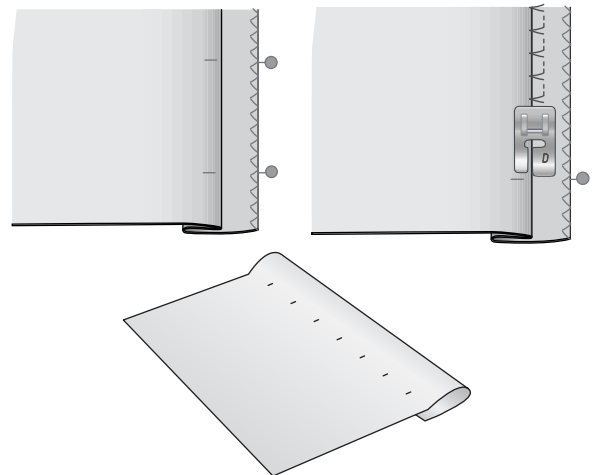

Hem

The hem technique on your JoyOS *advisor*TM feature will select the visible or topstitch hem that is best for your fabric weight and type. For woven fabric, leather and vinyl a straight stitch is selected. For stretch fabrics, stitches that stretch are selected.

Buttonholes

The JoyOS *advisor*TM feature will select the best buttonhole and stitch settings for your chosen fabric. Fabric should be interfaced and/or stabilized where buttonholes are to be sewn.

Tip: In your accessory tray there is a special book where you can hang your Sensor One-Step Buttonhole Foot.

Manual Buttonhole

Manual buttonholes are recommended for woven heavy fabric. To sew a manual buttonhole, use the buttonhole foot C.

1. Sew the first column as long as you want the buttonhole to be.
2. Touch the reverse button. The machine sews the bartack and the second column.
3. When the columns are aligned, touch the reverse button to sew the second bartack.
4. Touch the STOP function to sew the same length repeatedly.

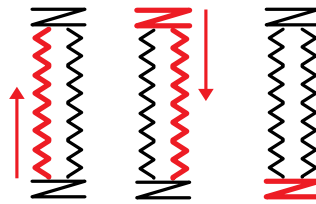

Sewing direction for buttonholes without satin stitches or satin stitch buttonholes sewn with presser foot C.

Automatic Buttonhole

When sewing buttonholes on woven light, woven medium, stretch light or vinyl fabric you can use the Sensor One-Step Buttonhole Foot. The Sensor One-Step Buttonhole Foot will sew automatic buttonholes. Read about how to attach the Sensor One-Step Buttonhole Foot.

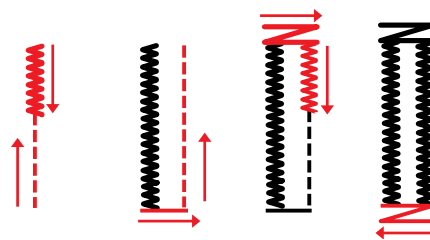

Sewing direction for satin stitch buttonholes sewn with the Sensor One-Step Buttonhole Foot.

Corded Buttonhole

Corded buttonholes are recommended when sewing buttonholes on stretch medium or stretch heavy fabric. Use gimp threads for a more stable durable and professional appearance. Use pearl cotton or a regular gimp thread. Attach the buttonhole foot C and use the finger on the back of the foot for holding the cord when sewing.

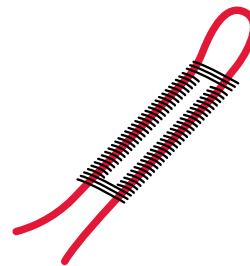

Programmable Button Sew On

Sew buttons, snaps, hooks and eyes quickly with your machine. Select sew on button in the JoyOS *advisor*TM feature.

Note: Place the thin end of the multipurpose tool under the button when sewing on light fabrics. Use the thick end for heavier fabrics. Hold in place on the fabric with transparent tape.

Note: The recommended width of 3.0 is set for most buttons. If you sew a tiny button or a very large coat button, decrease (-) or increase (+) the stitch width until the swing of the needle sews in the holes of the button or snap.

Note: An optional Button Foot for sewing on buttons can be purchased at your local authorized dealer.

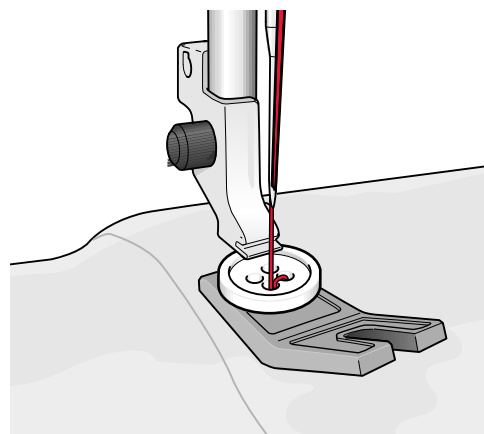

Start New

Always start with selecting the fabric you will sew on. If you want to start sewing without loading any sewing technique, touch the start new button in the bottom right corner. You will enter sewing mode with the selected fabric and a straight stitch will be loaded by default. In sewing mode you can view and select all built-in stitches in the machine from the stitch menu.

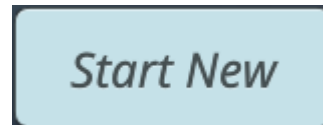

Continue

If a technique is loaded and you re-enter the JoyOS *advisor*TM feature a continue button with the current loaded JoyOS *advisor*TM project will be shown. In sewing you can select another fabric. Touch continue button to load the selected fabric into your current JoyOS *advisor*TM project.

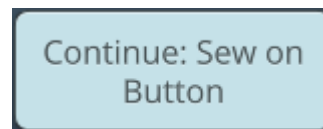

Load Smart Save

Smart save remembers and stores all sewing and embroidery adjustments and settings. This makes it possible to turn off your machine and continue sewing later.

Simply go to the JoyOS *advisor*TM button and touch load smart save button. The machine will load the stitch, embroidery and settings as it were when smart save was last performed.

Read about how to smart save.



Quilt Advisor

The Quilt Advisor gives you guidance for different kinds of quilting techniques. When selecting an quilting technique the machine will show all techniques for your chosen quilting technique group.

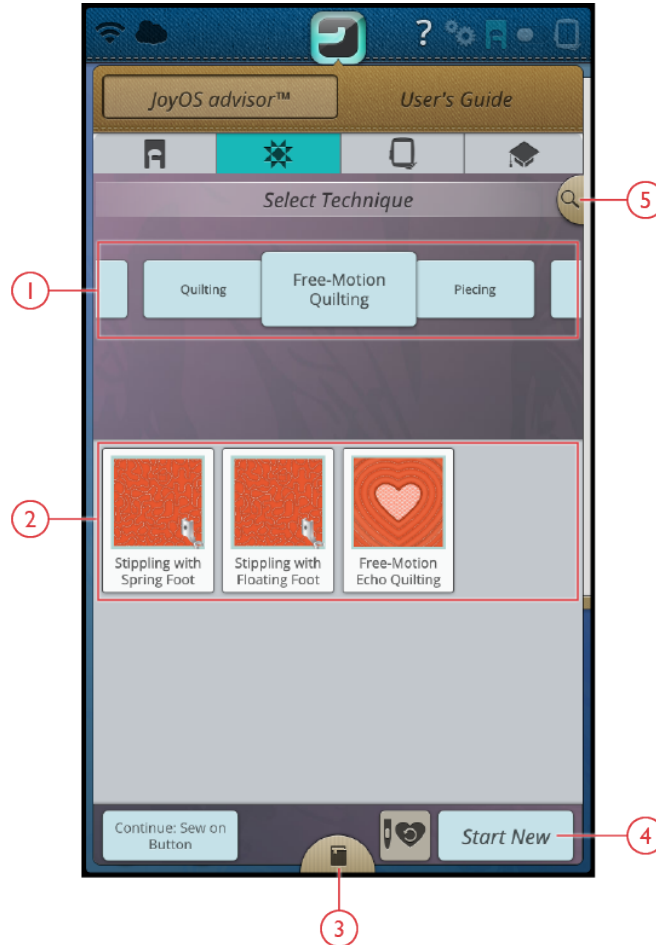

- 1. Quilting Technique Groups
- 2. Quilting Technique
- 3. Project viewer
- 4. Start New
- 5. Search JoyOS advisor™

Quilting Technique Groups

Touch an quilting technique group and the JoyOS advisor™ feature show available quilting techniques in that group. Touch a quilt technique to load it into the JoyOS advisor™ project viewer. There are 5 different quilting technique groups in the Quilting advisor.

Applique: is when attaching an appliqué fabric in different shapes and patterns to a larger piece of fabric. The appliqué fabric can be placed on top of or under your base fabric.

EMBROIDERY ADVISOR™ –

Overview

The EMBROIDERY ADVISOR™ gives you guidance for different kinds of embroidery techniques. When selecting an embroidery technique the machine will show all techniques for your chosen embroidery technique group.

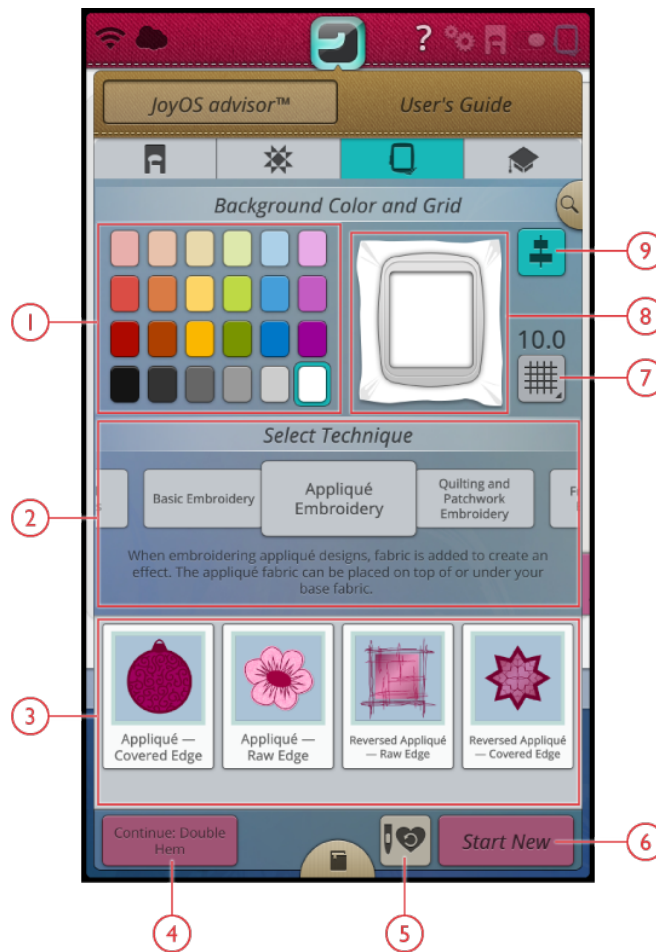

1. Background color
2. Embroidery technique groups
3. Embroidery techniques
4. Continue with current JoyOS advisor™ project
5. Load smart save
6. Start new
7. Grid options
8. Selected background color
9. Align embroidery designs

Background Color

Select a background color for the embroidery area that matches the color of the fabric you will use. Choose between different background colors. The selected background color will be shown in the hoop.



Grid Options

Touch the grid options button to activate a grid on the embroidery area to guide placement of designs. Touch again to remove the grid.

Touch & hold to open a pop-up where you can set the distance between the grid lines in millimeters/inches using the - and + buttons. You can also choose from 8 predefined grid options. Alternatively touch in the grid number area to open a keypad where you can enter a number.



Alignment

If activated, guides will appear when moving your design around the screen. This will help you to easier line-up two designs to one another.



Embroidery Technique Groups

After selecting a background color, touch an embroidery technique group and the JoyOS *advisor*TM feature show available embroidery techniques in that group. Touch a embroidery technique to load it into the JoyOS *advisor*TM project viewer.

Note: Use quick help on an embroidery technique for a short description of the technique.

Start New

If you want to start embroidering without loading an embroidery technique, touch the start new button in the bottom right corner. You will enter embroidery edit with the selected background color and grid if selected. All built-in designs will be shown in the design menu.



Continue

If a technique is loaded and you re-enter the JoyOS *advisor*TM feature a continue button with the current loaded JoyOS *advisor*TM project will be shown. In EMBROIDERY ADVISORTM you can select another background color and select/deselect grid. Touch continue button to load the new background color and/or grid into your current JoyOS *advisor*TM project.

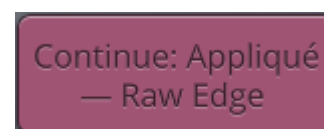

Load Smart Save

Smart save remembers and stores all sewing and embroidery adjustments and settings. This makes it possible to turn off your machine and continue embroidering later.

Simply go to JoyOS *advisor*[™] feature and touch load smart save button. The machine will load the stitch, embroidery and settings as it were when smart save was last performed.

Read about how to smart save.



Knowledge Center – Overview

The JoyOS *advisor*TM feature also contains a knowledge center including: stabilizer guide, quick start guide and sewing instructions.

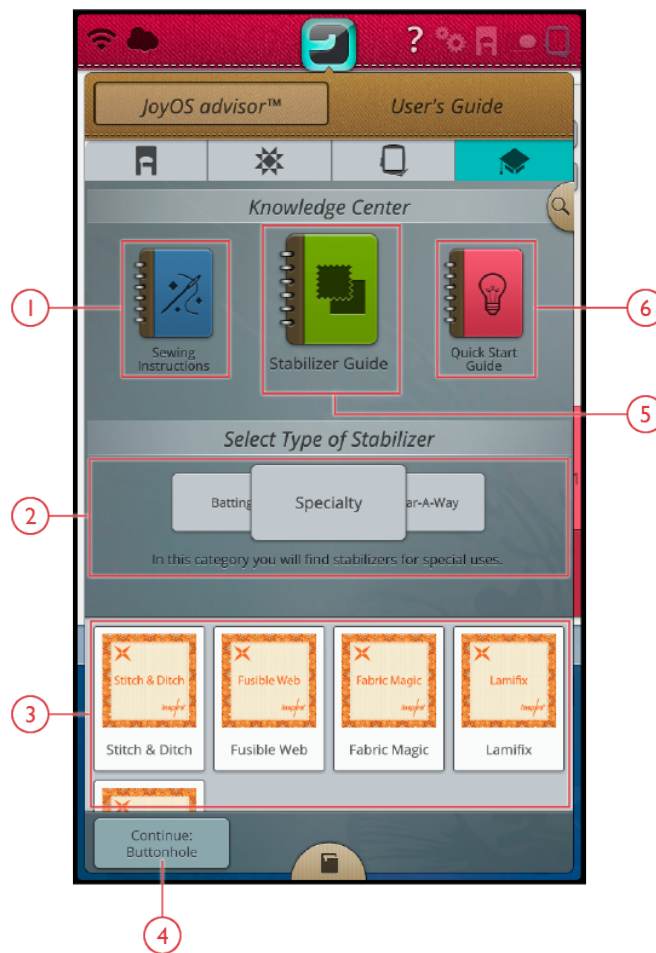

1. Sewing instructions
2. Group of techniques
3. Available techniques of chosen group
4. Continue with current JoyOS *advisor*TM project
5. Stabilizer guide
6. Quick start guide

Stabilizer Guide

Select a stabilizer group to view different stabilizers within the group. Touch a stabilizer to see more information about when to use it. The information about the stabilizer is shown in a viewer in the knowledge center. Close the viewer to select another stabilizer in the group.

- **Cut away:** Cut away stabilizers are stabilizers that need to be cut away by using scissors. It will stay on the fabric to make the embroidery more stable.
- **Batting:** Use batting between your top fabric and backing to add body to your JoyOS *advisor*TM project.
- **Water soluble stabilizer:** The stabilizers in this category are stabilizers that dissolve in water. They are very useful when embroidering lace and cutwork embroideries.
- **Specialty:** In this category you will find stabilizers for special uses.
- **Tear-a-way:** Tear-a-way stabilizers are temporary stabilizers. They are easy to remove after embroidering.

Quick Start Guide

Touch a quick start group to view different quick start guides within the group. Select one of the topics to get a guidance directly in a viewer within knowledge center. Some of the quick start guides will show animations.

Sewing Instructions

Touch sewing instructions to load techniques for complete project instructions.

Continue

If a JoyOS *advisor*TM project is loaded and you re-enter the JoyOS *advisor*TM feature, a continue button with the current loaded JoyOS *advisor*TM project will be shown. Touch the continue button or the JoyOS *advisor*TM feature button.

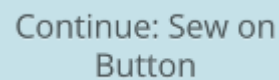

Continue: Sew on
Button

7 Sewing

Getting Started to Sew

When your DESIGNER BRILLIANCE™ 80 machine starts, the JoyOS *advisor*™ feature will be opened automatically.

Always make sure that the type of fabric you intend to sew on is selected in the JoyOS *advisor*™ feature.

Read more about the fabric selections.

After your fabric is chosen, select a special sewing technique you would like to sew or you can touch start new. When a special sewing technique is chosen you will receive detailed instructions in the JoyOS *advisor*™ project viewer. If you touch start new you will enter sewing mode and the straight stitch will be loaded by default. Read more about the JoyOS *advisor*™ feature.

Sewing Mode – Overview

In sewing mode you can select stitches, adjust and sew them. Your selected stitch will be shown in actual size in the stitch field. The sewing recommendations will be shown at the top.

You can also go to program mode to create your own stitch program. Read more about how to program stitches in program.

Note: All symbols and options will not be shown at the same time.

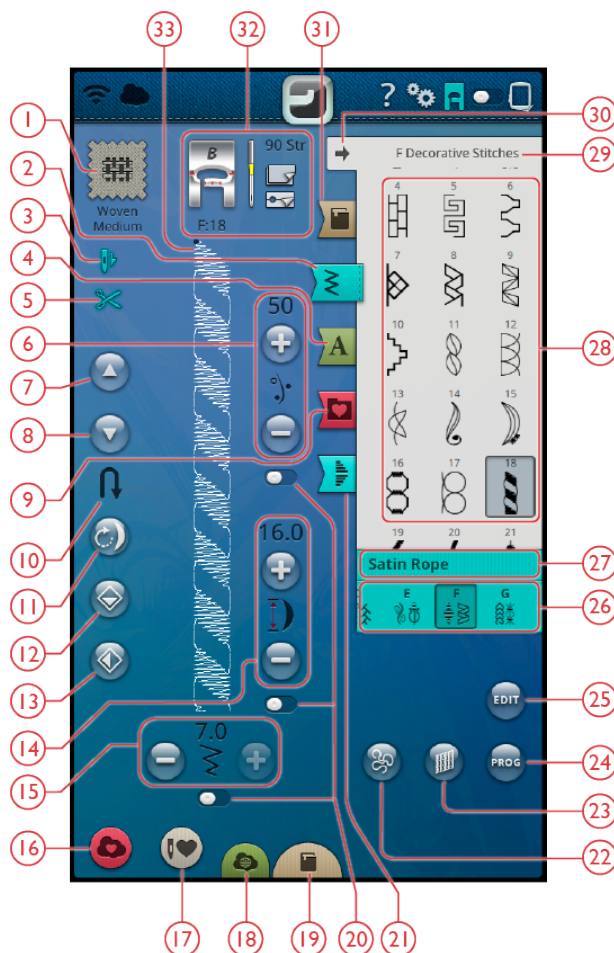

- | | | |
|--|-------------------------------------|------------------------------------|
| 1. Fabric selected | 12. Mirror end to end | 23. Balance stitch |
| 2. Stitch menu | 13. Mirror side to side | 24. New program |
| 3. Needle stop down | 14. Stitch length/stitch density | 25. Edit stitch program |
| 4. Font menu | 15. Stitch width/stitch positioning | 26. Stitch categories |
| 5. Cut is requested | 16. Save | 27. Stitch information |
| 6. Thread portioning/thread tension/sensor foot pressure | 17. Smart save | 28. Selection area |
| 7. Step to previous stitch | 18. mySewnet™ Blog | 29. Stitch menu name |
| 8. Step to next stitch | 19. JoyOS advisor™ project viewer | 30. Minimize/expand selection area |
| 9. File manager | 20. Alternative switch bar | 31. JoyOS advisor™ project menu |
| 10. Step to next part of stitch | 21. Tapering menu | 32. Sewing recommendations |
| 11. Stitch re-start | 22. Free motion options | 33. Stitch start |

What is a Stitch?

A stitch either consists of a single stitch as in a straight stitch, or as two individual stitches e.g. in a zigzag. Furthermore, a stitch is also the complete stitch meaning it is made up by the total of the individual stitches in the stitch, such as a 3 step zigzag or a decorative stitch.

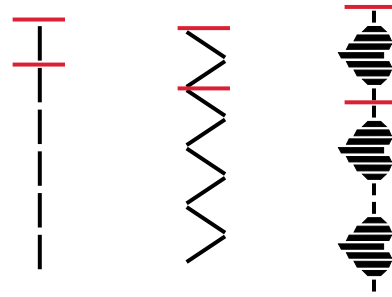

Select a Stitch or Letter

To load a stitch, select the stitch menu and touch the stitch in the selection area to select it. The selected stitch will automatically be loaded and information about the selected stitch will be shown in the stitch information area. Swipe up and down in the selection area to scroll through the stitches within the selected category. Swipe left/right in the selection area to scroll to and select a different stitch category. Alternatively swipe left/right in the category list and touch a category to select it. The selection area will be updated and show the stitches in the selected category.

To create text, select the font menu and touch a font to select it. When a font is selected it will automatically be loaded to a new program and a keyboard will be shown. Program your text by touching letters in the keyboard. Minimize the keyboard and touch OK in the program window. Your text will be loaded to sewing mode and ready to be stitched out. Learn more on how to program stitches and letters in the program chapter.

Load a Stitch or Letter From Another Location

Load stitches or programs that you have saved in your *mySewnet*™ cloud folder or on a USB device from file manager. Touch file manager and load a stitch or program by touching & holding on the file. In file manager you will see all your saved files e.g. stitches, designs and fonts. Learn how to organize your files in file manager.

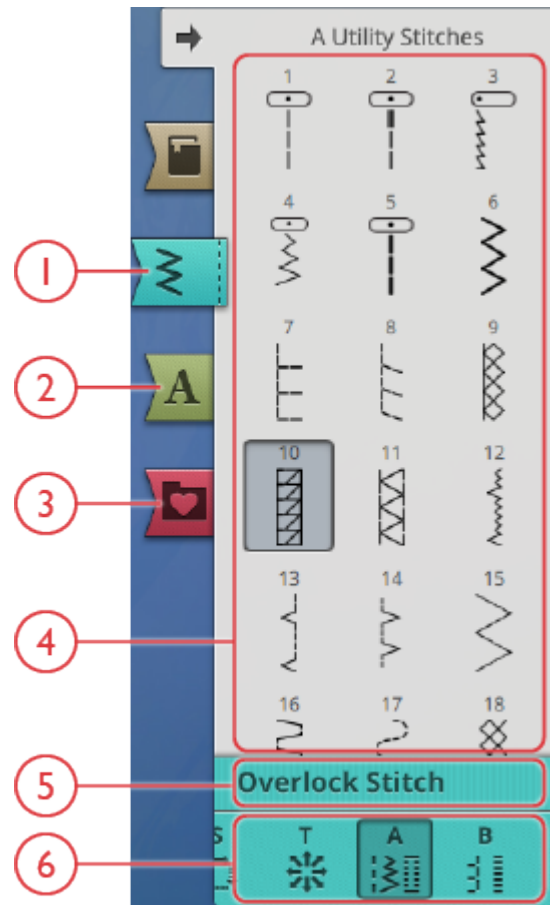

1. Stitch menu
2. Font menu
3. File manager
4. Selection area
5. Stitch information
6. Stitch categories

Stitch Settings

Your machine will set the recommended settings for each selected stitch. You can make your own adjustments to the selected stitch. The changes will only affect the selected stitch and will be reset to default when selecting another stitch or turning your machine off. To save your adjusted stitch, touch save.

The controls available on the screen will change depending on what stitch or program is loaded. Some stitches have more than one control, and an alternative switch bar will appear below the control. Touch the alternative switch bar to change to an alternative control for a different stitch setting. Touch it again to change back to the previous control. The different stitch settings are described below.

Note: When trying to exceed minimum or maximum settings for width and length, a warning sound will be heard. The default setting is always shown in black numbers.

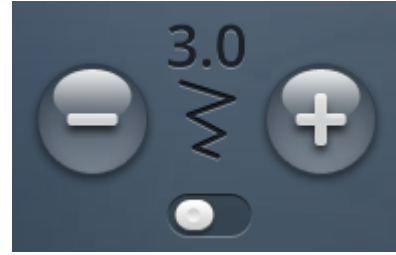

Stitch Width

Increase or decrease the stitch width using + and - in the control. The number above the control shows stitch width in mm.

Changed stitch position may limit the stitch width adjustments.

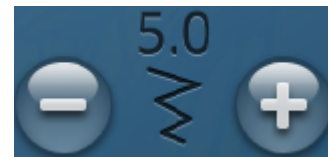

Stitch Positioning

On certain stitches with a width less than 7mm it is possible to change the stitch position. Use + to move the stitch to the right and - to move the stitch to the left. The number above the control shows the needle start position in mm in relation to center needle position. The machine has a maximum of 29 needle positions (for a straight stitch).

The stitch position can only be changed to the limit of the maximum stitch width. Changing the stitch positioning will also limit the stitch width adjustments.



Stitch Length

Increase or decrease the stitch length using + and - in the control. The number above the control shows the set stitch length in mm. If lengthening a zigzag stitch or a decorative stitch, the entire stitch will be stretched out. If lengthening a stitch where the density can be adjusted, the entire stitch will be longer but the density of the satin stitches will remain the same.



Stitch Density

The stitch density control adjusts the density (the distance between the individual satin stitches that make up the entire stitch). The density does not affect the actual length of the entire stitch.

Touch + to decrease the density. Touch - to increase the density. The number above the control shows the distance between satin stitches in mm.

Tip: Decrease the density to get different visual effects e.g. when using speciality threads.



Button Size

When sewing a buttonhole with the Sensor One-Step Buttonhole Foot, you can set the button size. Measure your button with the ruler on the front of the machine and set the button size in the button size control. Sew a test buttonhole on a fabric scrap to verify the desired length of the buttonhole.



Sew On Button

When sewing a button, you can set the number of stitch repeats. Touch the + or - in the control to increase or decrease the number of stitch repeats.



Sensor Foot Pressure

Touch + to increase or - to decrease the pressure of the presser foot on the fabric.

Note: Touch the alternative switch bar on the thread portioning/thread tension control to switch to sensor foot pressure control.

EXCLUSIVE SENSOR SYSTEM™

Thanks to the EXCLUSIVE SENSOR SYSTEM™ feature, the presser foot automatically and continuously senses and adjusts as you sew any thickness of fabric for perfect even feeding.

Go to sewing mode to see the actual setting of the sensor foot pressure for the selected fabric and adjust the presser foot pressure.



deLuxe™ Stitch System

The deLuxe™ stitch system has two ways to control the upper thread: thread portioning and thread tension. To get the best sewing result it will automatically use thread portioning when possible. Thread portioning automatically and continuously measures the fabric thickness to portion the correct amount of thread for the selected stitch.

When thread tension is used, the tension discs will keep the correct amount of tension on the upper thread. Some special techniques may require the use of thread tension. Deselect the deLuxe™ stitch system in the temporary sewing settings to ensure that thread tension is engaged. When the deLuxe™ stitch system is selected in temporary sewing settings the control visible in sewing mode will change between thread portioning and thread tension depending on the current settings and the loaded stitch.

Use the thread portioning/thread tension control to adjust the balance between needle thread and bobbin thread, e.g. decrease when using metallic thread and increase when using heavy weight thread. Make a few tests with different settings on a scrap piece of the fabric you are going to use and check the balance between the upper thread and the bobbin thread.

Note: When changing the value of the thread portioning/thread tension setting, the changes only affect the selected stitch. Your changed settings will be reset to default when selecting another stitch.

Tip: Increase the thread portioning/thread tension setting for best results when sewing on denim fabric with thick threads.

Adjust Thread Tension/Thread Portioning

For the best stitch appearance and durability make sure the threads meet evenly between the two fabric layers.

If the bobbin thread is visible on the top side of the fabric, the thread tension/thread portioning is too tight. Reduce the thread tension/thread portioning.

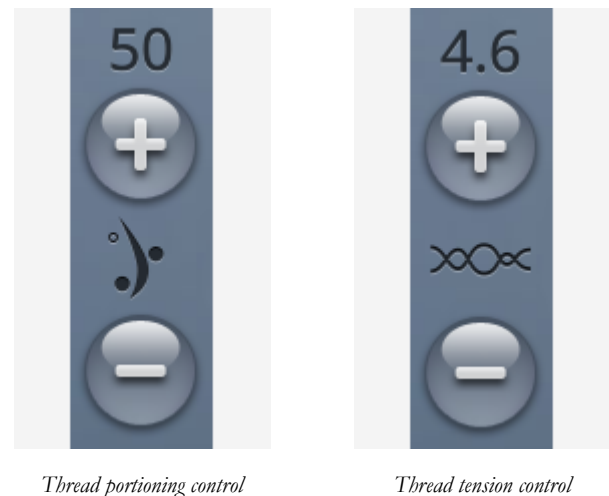

Thread portioning control

Thread tension control

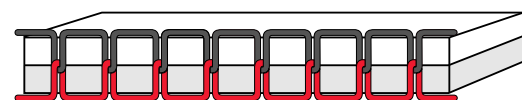

Correct tension

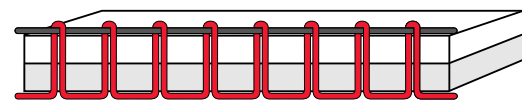

Tension too tight

If the upper thread is visible on the back side of the fabric, the thread tension/thread portioning is too loose. Increase the thread tension/thread portioning.

For decorative stitches and buttonholes the upper thread should be visible on the back side of the fabric.

Make a few tests on a scrap piece of the fabric you are going to use and check the tension.



Tension too loose

Mirroring

To mirror a stitch or stitch program lengthwise, touch the mirror end to end button. To mirror a stitch or stitch program sideways, touch the mirror side to side button.

Tip: Use the smart toolbox to open a shortcut for mirroring.

Note: Some stitches e.g. buttonholes cannot be mirrored.

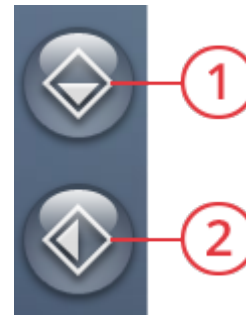

1. Mirror end to end
2. Mirror side to side

Stitch Re-Start

When you stop sewing in the middle of a stitch, touch stitch re-start to begin sewing at the beginning of the stitch. The stitch or stitch program will remember any special settings you made.



Balance

When sewing on special fabrics or doing a special technique, the balance may need to be adjusted. To adjust the balance on the active stitch, touch the balance button in sewing mode.

Start by sewing the stitch on a piece of scrap fabric. Change the preview on the screen to match your sewn sample by using the + and - in the controls. When you sew again, the balance will be corrected.

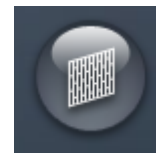

Balance button in sewing mode

Free Motion Options

Choose between two free motion options: free motion spring action or free motion floating.

When sewing free motion with a straight stitch, use the Straight Stitch Plate for best result. Read about how to change to Straight Stitch Plate.



Free Motion Spring Action

Activate free motion spring action to set the machine in free motion spring action mode for spring action feet, e.g. the Sensor Q-Foot. The feed teeth will lower automatically.

A spring action foot will raise and lower with each stitch to hold the fabric on the needle plate while the stitch is being formed. When sewing, you need to move the fabric manually.

Sensor Q-Foot is recommended for all free motion sewing except when using specific techniques or accessories that do not support the use of Sensor Q-Foot.



The free motion spring foot icon will be shown in the sewing recommendations.

Tip: There is an optional open toe free motion spring foot that can be purchased at your local authorized retailer.

Free Motion Floating

Activate free motion floating to set the machine in free motion floating mode for floating feet, e.g. the R-Foot. The feed teeth will lower automatically.

When sewing at low speed the presser foot will raise and lower with each stitch to hold the fabric on the needle plate while the stitch is being formed. At higher speed, the presser foot floats over the fabric while sewing. The fabric must be moved manually.

Skipped stitches can occur if your fabric moves up and down with the needle as you are stitching. Lowering the presser foot height will reduce the space between the presser foot and the fabric and eliminate the skipped stitches.

Note: Be careful not to reduce the presser foot height too much. The fabric must still move freely under the presser foot.

To adjust the presser foot height in free motion floating mode, touch the presser foot height control to make adjustments.



The free motion floating foot icon will be shown in the sewing recommendations.

Note: If free motion floating is activated, do not use a spring action foot, as this might damage the presser foot.

Note: Activate stitch width safety if the presser foot requires it.

Sewing Recommendations

On top of the screen your machine will show the selected fabric and the active stitch. It will also show sewing recommendations which are set automatically depending on the selected fabric, active stitch and current settings. The following recommendations can be shown: presser foot, needle, stabilizer and glide plates. The Straight Stitch Plate recommendation will be shown when a free motion option is selected with a straight stitch.

Tip: We recommend that you use the knowledge center in the JoyOS advisor™ feature and the stabilizer guide for detailed information about the different stabilizers.

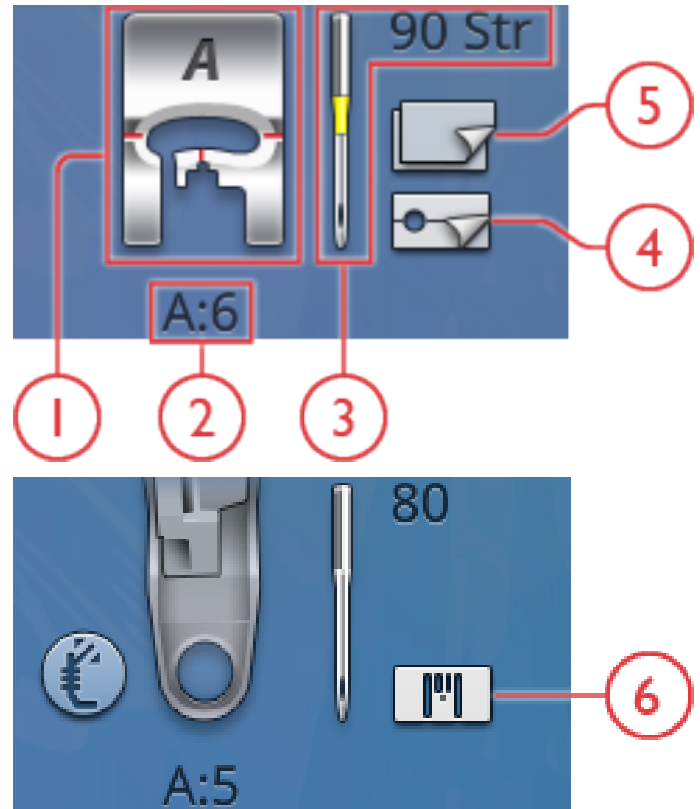

1. Presser foot recommendation
2. Needle recommendation
3. Stitch selected
4. Glide plates recommendation
5. Stabilizer recommendation
6. Straight Stitch Plate recommendation

Save Stitch

To save your file, touch the save button and a pop-up will appear on the screen. In the save pop-up you can choose to save the file to the *mySewnet*TM cloud folder or to a USB device. Previously saved designs, stitches, programs and/or fonts are shown. Name your file with the keyboard and touch the OK button.

If you want to save to a folder, simply touch & hold on the folder to open it, then name your file with the keyboard and touch OK in the pop-up to confirm. To create a new folder, simply touch the create new folder button, name the folder with the keyboard and touch OK. Then touch & hold on the folder to open it and save into the new folder.

Touch the list and thumbnail view button to toggle between showing the files in a list or as thumbnail icons. In list view each file is shown with the file name and file type. In thumbnail view each file is shown with the file name and a thumbnail image of the file.

To cancel the save process, close the pop-up window by touching cancel. The save pop-up will close and you will return to sewing mode.

Read more about organizing your saved stitches in file manager.

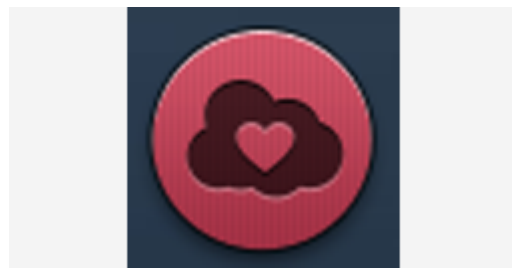

Save button

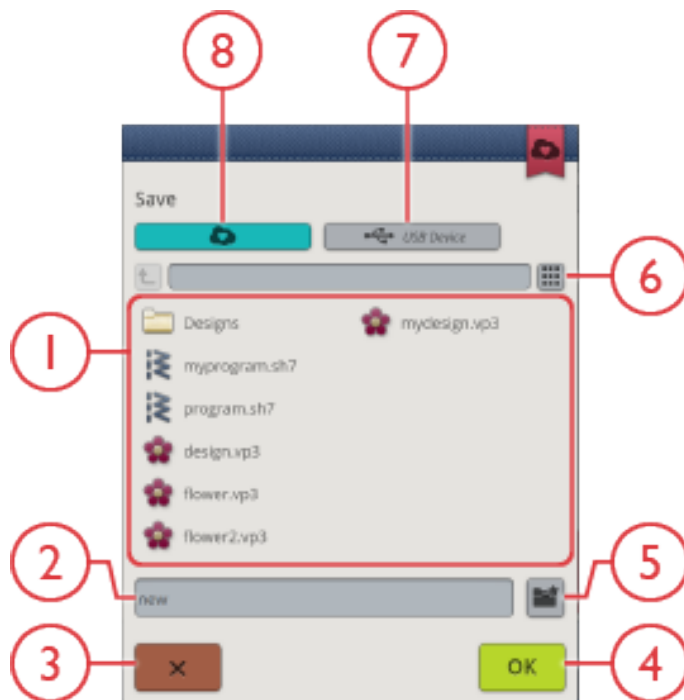

- | | |
|----------------------|---|
| 1. Selection area | 6. List and thumbnail view |
| 2. File name | 7. Save to USB device |
| 3. Cancel | 8. Save to <i>mySewnet</i> TM cloud folder |
| 4. Confirm | |
| 5. Create new folder | |

Smart Save

If you want to stop sewing and save your current stitch and settings, touch the smart save button. A pop-up will indicate that a smart save has been done and you can now turn off the machine.

Smart save remembers and stores the stitch, embroidery and settings as they were when smart save was last performed. This makes it possible to turn off your machine and continue sewing later. To load smart save, touch the load smart save button in the JoyOS *advisor*TM feature.

Your smart save will be saved until you touch the smart save button again and replace it.



JoyOS *advisor*TM feature button



Load smart save button

Dimensional Stitches – Menu L

Menu L – dimensional stitches includes three types of stitches: appliqué, pop-up and sequin stitches. In this menu there will also be combined appliqué and pop-up stitches. Since every stitch is unique, these stitches will give different decorative effects depending on which stitch is selected and what type of fabric you have chosen.

Tip: We recommend you to use your JoyOS advisor™ feature and locate the dimensional stitches project for instructions on how to sew dimensional stitches and automatically get the correct settings.

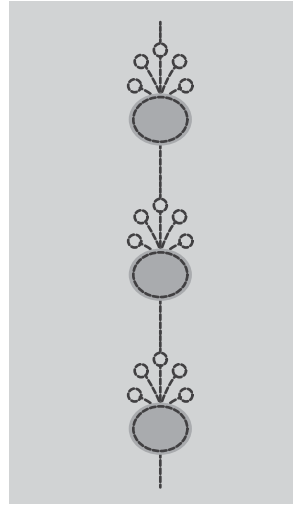

Example of appliqué stitch

Theme Stitches – Menu M

Theme stitches are beautiful coordinating stitches, in a group of four, designed to be sewn out together in a random combination. Touch the reverse button on the front of your machine or the reverse button on the screen to change to the next stitch in the group. If you touch the reverse button twice – quickly – you will skip the next stitch in the group.

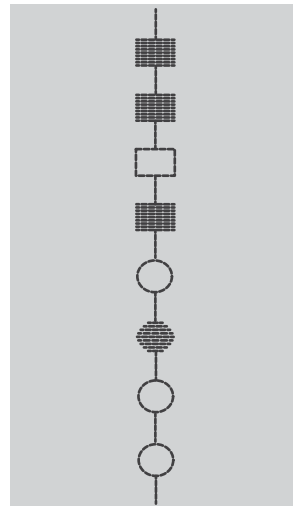

Example of theme stitch



Reverse button on the screen

Embellished Stitches – Menu N

Embellished stitches are decorative stitches where you can change the appearance of the stitch after it is sewn for a special effect. These stitches can be decorated with crystals or cut for a tassel effect.

Tassel stitches are sewn with many threads on top of each other. The threads can either be left as they are sewn or cut to create a 3D effect. The long stitches should be cut at the very edge and from the top side of the fabric. To make the cutting easy, use a seam ripper.

Tip: For heavier threads, use the optional Specialty Candlewicking Foot (part number 413 16 23-45) for easier feeding.

Crystal stitches may be used as is or they may be further embellished by attaching crystals in the sewn circles.

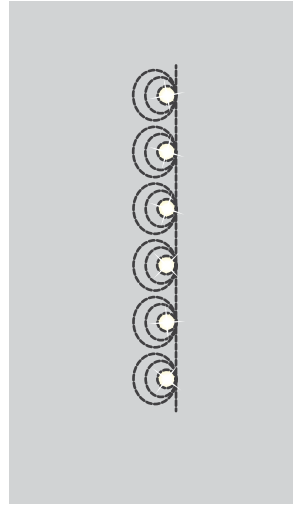

Example of crystal stitch

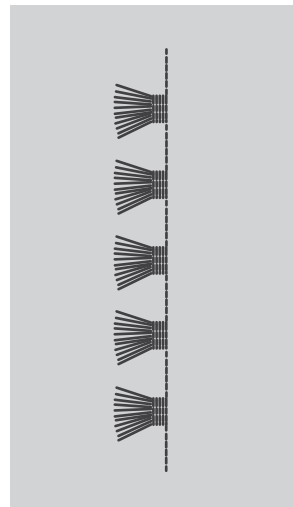

Example of tassel stitch

Tapering Stitches – Menu Q

The tapering menu will be visible when a stitch that can be tapered is selected. Touch the tapering menu to open a view of angles for beginning and end tapers. Select an angle by touching it in the selection area. The machine will sew the beginning tapered point and then continue with the selected stitch. When the desired length has been sewn, touch the reverse button. The stitch will taper to the end.

Select taper “off” to remove any tapering at the beginning or end of the stitch. If you select taper “off” on both the beginning and end, the stitch will be a regular stitch without tapering.

Taper Satin Stitch Exercise

The taper stitch automatically tapers the satin stitch for corners and points and can be used for satin stitch lettering. Try the satin stitch exercise and stitch a corner of the tapered satin stitch on a piece of stabilized fabric.

1. Select stitch Q1 in menu Q - Decorative tapering stitches.
2. Open tapering and select 45 degrees for both beginning and end.

Note: For a wider satin stitch, adjust the stitch width control.

3. Activate needle stop up/down on your machine and start to sew. The machine will sew the tapered point and then continue with a satin stitch at the selected width.
4. When the satin stitch is as long as desired, touch the reverse button. This will start the end tapering.
5. Turn your fabric to continue with the next tapered satin stitch. Activate the STOP function to repeat the previously stitched length, including the beginning and end tapers.

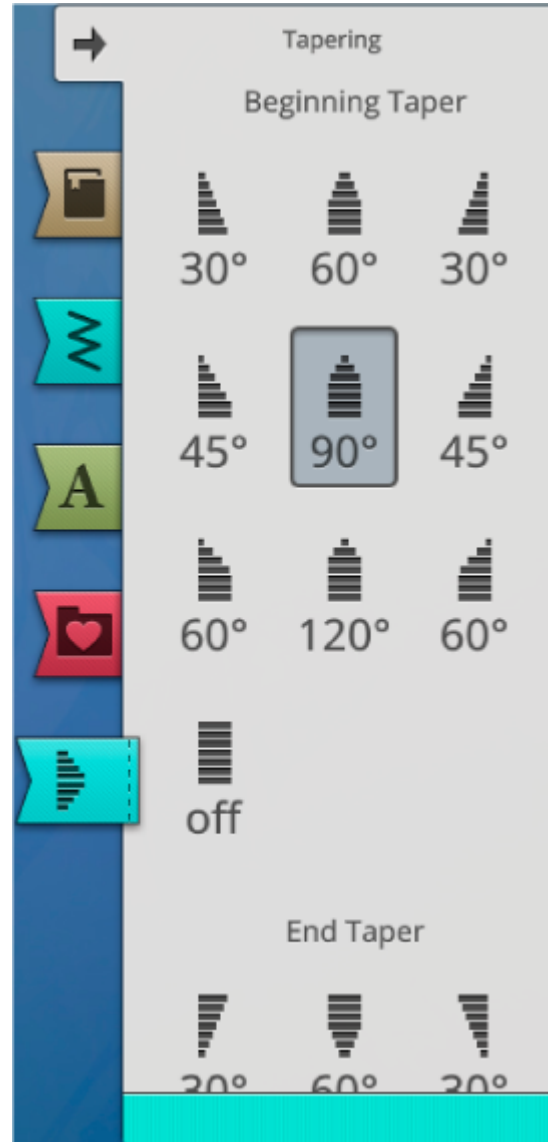

4-Way Stitches – Menu S

The 4-way stitch allows you to sew several sturdy stitches in four different directions. You will have different 4-way stitches to choose from. This is especially helpful when patching trouser legs on a free arm. The 4-way stitches are programmed at a fixed length and stitch width.

4-Way Stitches Exercise

Fabric: Woven heavy, two pieces, one a patch.

Select: Woven heavy on your JoyOS *advisor*TM feature, menu S – 4-way stitches, stitch 8.

Use: Presser foot S and size 90 needle as recommended.

Sew:

1. Place the patch on the larger piece of fabric and position the top left corner of the patch under the presser foot. The machine will sew across the top from the left to the right as shown on the screen.
2. Sew across the top and touch the reverse button or the 4-way sewing direction button (reverse button on the screen) to change the sewing direction. The direction of the stitch on the screen will change. Step on the foot control. The presser foot lowers automatically.
3. Sew down the side of the patch. Continue sewing around the patch, touching the reverse button or the 4-way sewing direction button on the screen, to change the sewing direction.
4. Touch the cut function.

Tip: To sew beautiful corners with 4-way stitches, touch the STOP function before changing the sewing direction. This will complete the current stitch before changing the direction.



4-way sewing direction button (reverse button on the screen)

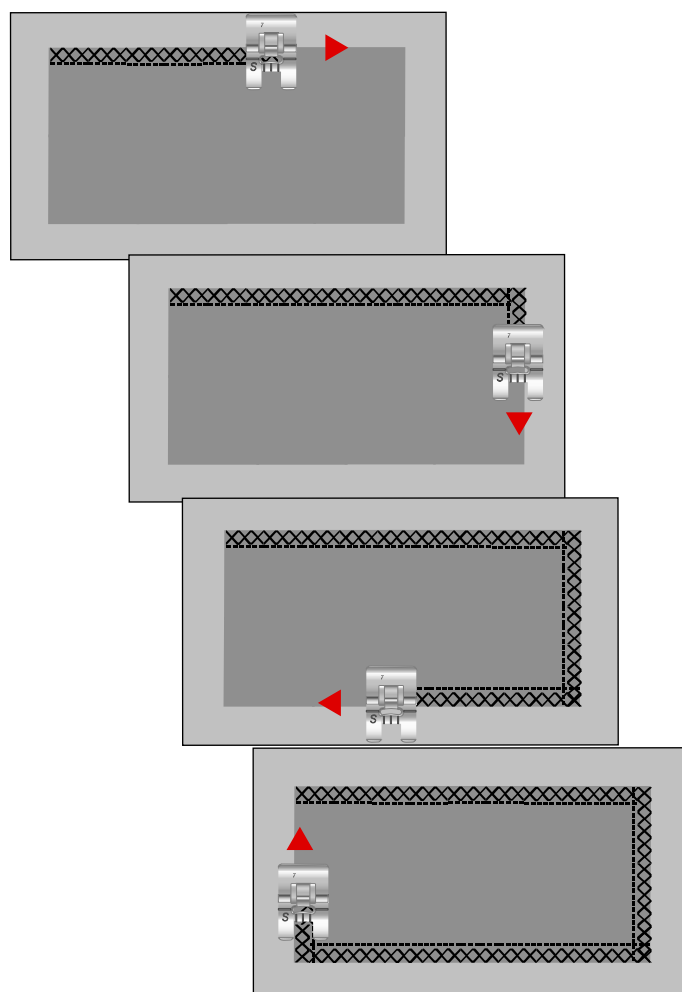

8-Way Stitches – Menu T

There are two different stitches, straight and reinforced straight stitch, in the T menu. Touch the arrows to select one of the pre-set sewing directions. To fine tune the direction of the stitch, use the stitch width and stitch length controls. Program these stitches alone or with decorative stitches from other menus to create unique stitches or borders.

8-Way Stitches Exercise

Fabric: Woven medium and stabilizer.

Select: Woven medium on your JoyOS *advisor*TM feature, menu T - 8-way stitches.

Use: Thread your machine with embroidery thread on top and bobbin thread in the bobbin. Use presser foot S and size 80 needle as recommended.

Sew:

1. Touch the program button.
2. Select stitch 1 in menu H - children stitches.
3. Select T menu and click 3 times on the straight stitch to the right.
4. Select stitch 1 in menu H.
5. Select T menu and click 3 times on the straight stitch to the right.
6. Select stitch 1 in menu H.
7. Select T menu and click 3 times on the straight stitch to the left.
8. Select stitch 1 in menu H.
9. Select T menu and click 3 times on the straight stitch to the left.
10. Touch OK to enter sewing mode again.
11. Place the fabric and stabilizer in position under the presser foot. Press the foot control to lower the presser foot and start sewing your programmed stitch.

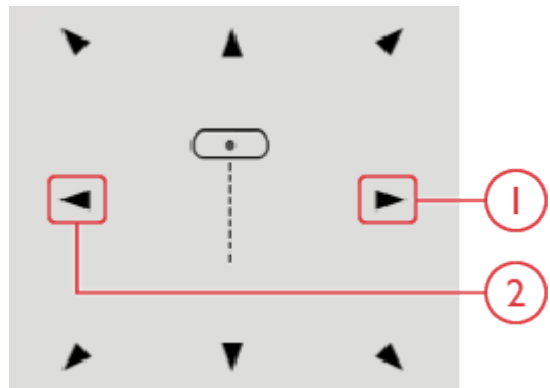
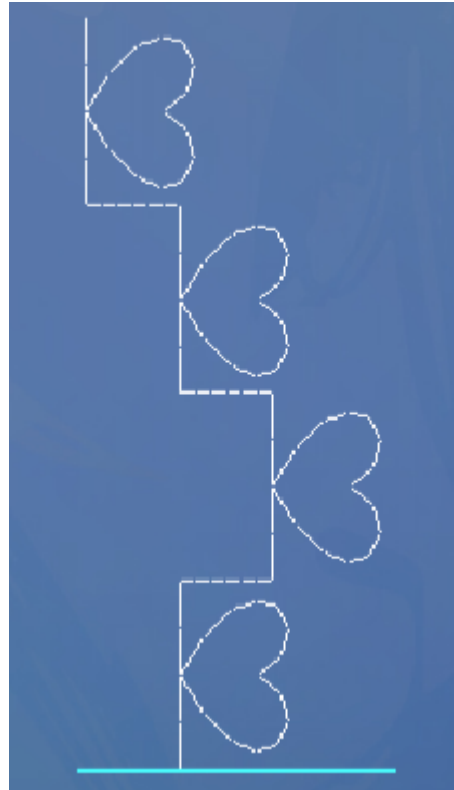

1. Straight stitch right
2. Straight stitch left

Special Stitches For Optional Presser Feet

Stitch menu P- specialty stitches, includes special stitches like candlewicking and edge stitches. These techniques may require special presser feet and accessories. This is indicated by the optional presser foot icon on the screen.

Tip: Detailed information on the current selected stitch is shown in the stitch information.



Sewing Pop-up Messages

The Bobbin Thread is Running Low

When the bobbin thread is running low, a pop-up message appears giving you notice that you will soon need to change the bobbin. This gives you an opportunity to plan when you want to change your bobbin. If you want to continue sewing without changing the bobbin, touch the foot control and do not close the pop-up.

Check Upper Thread

The machine stops automatically if the upper thread runs out or breaks. Re-thread the upper thread, close the pop-up message and start sewing.

Remove Sensor One-Step Buttonhole Foot

The Sensor One-Step Buttonhole Foot is used only for buttonholes. A pop-up message will advise you to remove the foot for all other sewing.

Remove Twin Needle and Turn Off Twin Needle in Settings

This pop-up message appears when you choose a stitch not suitable for twin needle.

Machine Set for Straight Stitch with Center Needle Position (Stitch Width Safety)

When stitch width safety is activated, this pop-up message appears when you choose a stitch not suitable for stitch width safety.

Attention!

If the machine stops and this pop-up appears on the screen you need to stop sewing. Wait a moment and touch the OK button when it is enabled. Check the needle size and condition. Check for correct threading.

8 Embroidery

Getting Started to Embroider

When your DESIGNER BRILLIANCE™ 80 machine starts the JoyOS *advisor*™ feature will be opened automatically.

Select a special embroidery technique or touch start new. When a special embroidery technique is chosen you will have directions from the JoyOS *advisor*™ feature. When you touch start new you will enter embroidery mode with the selected background color.

Read more about the JoyOS *advisor*™ feature.

Embroidery Edit – Overview

In embroidery edit you can adjust, combine, save and delete designs, stitches and fonts. You can edit your design combinations without having the embroidery unit connected

to your machine. The loaded design(s) are shown in the embroidery area.

Tip: Minimize the selection area by touching expand/minimize selection area to use the whole screen when editing your design combinations.

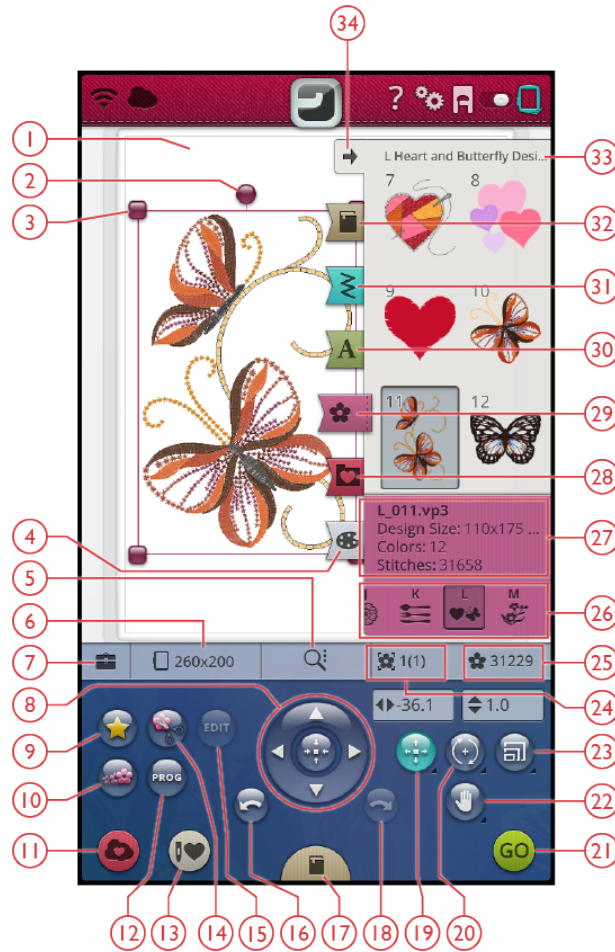

- | | | |
|----------------------|---|---|
| 1. Embroidery area | 13. Smart save | 25. Total number of stitches in design combination |
| 2. Rotate handle | 14. Design appliqué | 26. Design categories |
| 3. Scale handles | 15. Edit | 27. Design information |
| 4. Thread color edit | 16. Undo | 28. File manager |
| 5. Zoom options | 17. JoyOS <i>advisor</i> TM project viewer | 29. Design menu |
| 6. Hoop selection | 18. Redo | 30. Font menu |
| 7. Toolbox | 19. Position | 31. Stitch menu |
| 8. Control wheel | 20. Rotate | 32. JoyOS <i>advisor</i> TM project menu |
| 9. Design shaping | 21. Go to embroidery stitch out | 33. Design menu name |
| 10. Resize | 22. Pan | 34. Minimize/expand selection area |
| 11. Save | 23. Scale | |
| 12. Program | 24. Design stitch out order | |

Load a Design

Touch & hold a design for a few seconds to activate it and then drag the design to the embroidery area without releasing your finger from the screen. To place the design, release your finger from the screen and the design will be placed into the embroidery area.

Swipe up/down in the selection area to scroll through the designs within the selected category. Swipe left/right in the selection area to scroll to and select a different design category. Alternatively swipe left/right in the category list and touch a category to select it. The selection area will be updated and show the designs of the selected category. When a design is selected, information about the design will be shown in design information.

Note: You can also load saved designs from the mySewnet™ cloud folder and from a USB device in file manager.



Load a Stitch

Touch & hold a stitch from the stitch menu for a few seconds to activate it and then drag the stitch to the embroidery area without releasing your finger from the screen. To place the stitch, release your finger from the screen and the stitch will be placed into the embroidery area.

Note: You can also load saved stitches from the mySewnet™ cloud folder and from a USB device in file manager.

Note: Touch a stitch to get information about the selected stitch.



Load a Font

Text can be created both with embroidery fonts and stitch fonts. Select a font by opening the font menu and touching your desired font on the screen. If you choose an embroidery font, the program embroidery text window will open. If you choose a stitch font it will be loaded to program. Stitch fonts are shown in black while embroidery fonts are shown in color. The created text will then be loaded into the embroidery area. If you want to edit your text, select your text and touch the edit design button or use the smart toolbox.

Note: You can also load saved fonts from the mySewnet™ cloud folder and from a USB device in file manager.



File Manager

Touch the file manager button to open file manager and locate your saved design, stitch or font. In file manager you can load files from the mySewnet™ cloud folder, built-in designs and from a USB device. Touch & hold to load a design, stitch or font. To load several designs, stitches and/or fonts, activate multi-select and select your files. Touch & hold on one of the selected files to load all selected files into the embroidery area.

Read more about organizing your saved designs, stitches and fonts in file manager.



Toolbox

In embroidery edit several edit functions can be found in the toolbox. Touch the button to open the toolbox and touch it again to close.

Tip: Use smart toolbox on the screen to open a shortcut for some edit functions.



Move to Hoop

A red frame will surround the embroidery area if a design is placed outside the hoop area. Touch move to hoop to move any design that is outside the hoop area into the hoop area. The design will be placed at the outermost edge of the hoop.

Tip: If you want to place a design e.g. in the top left corner as near as possible easily, touch and drag your design to the top left corner. Make sure that the design is placed outside the hoop area. Touch move to hoop and the design will be placed at the top left corner of the hoop area, as close to the hoop edge as possible.



Delete

When you touch delete, the selected design(s) will be deleted from the embroidery area. If more than one design is selected, a pop-up message will appear. Touch OK to confirm to delete all designs. Touch & hold to delete all loaded designs from the embroidery area and touch OK in the pop-up window to confirm.



Duplicate

Touch duplicate to make a copy of the selected design(s). Touch & hold on the duplicate button to add more than one copy of the selected design(s). A keypad will appear on the screen where you can enter the desired number of copies.



Mirror Side to Side and End to End

To mirror a design horizontally, touch the mirror side to side button. To mirror vertically, touch the mirror end to end button.

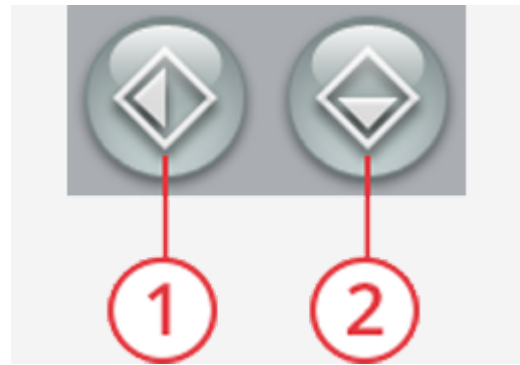

1. Mirror side to side
2. Mirror end to end

Stitch Out Design Earlier/Later

To change the design stitch out order without having to start over and load the designs again, you can use the stitch out design earlier/later buttons. Select the design you wish to stitch out earlier/later and touch one of the buttons to change the design order. The design will move in the selection window to show the changed stitch out order. Read more about design stitch out order.



1. Stitch out design earlier
2. Stitch out design later

Group/Ungroup

If you have selected two or more designs and want to combine them to be adjusted as one design, touch the group/ungroup button. A design selection frame will surround each design that is selected and, when grouped, the design selection frame will surround all of the designs in the group. To ungroup, touch the group/ungroup button again and they will once again become individual designs.



Select All

If you want to select all designs, simply touch the select all button. All designs on your screen will be surrounded by design selection frames. You can now make changes to all of the selected designs. If you want to combine all the designs into one design, touch group/ungroup button.



Multi-Select

Multi-select allows you to select two or more of the designs on your screen at the same time. Touch the multi-select button and then touch the designs on the screen you want to select. Alternatively select the thumbnail pictures in the selection window. A design selection frame will surround the selected designs; both the thumbnail pictures in the selection window and the designs in the embroidery area. To deselect, touch the designs again and the design selection frame will disappear.



How to Select Designs

When loading designs into embroidery edit, the last loaded design is selected by default.

Select One Design

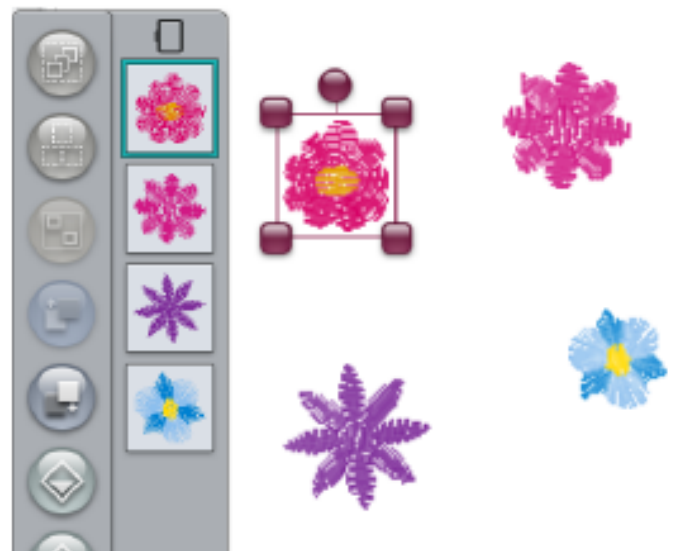

To select one design you can either touch the design on the screen or open the toolbox and touch the thumbnail image in the selection window. To see the order your designs will be embroidered, read about design stitch out order.

Select Design Exercise

1. In embroidery edit, touch the design menu.
2. Touch & hold a design in the design menu to activate it, then drag to the embroidery area and release to load it. Do this four times with different designs.
3. The last design will be surrounded with a design selection frame which means that it is selected.

4. If you want to select the first design you inserted, touch the design on the screen. Alternatively touch the toolbox and select the thumbnail image for the first design in the selection window.
5. To select more than one design, touch the multi-select button. Touch the designs you want to select.
6. Once you have selected the design(s), you can delete, duplicate, position, scale, mirror and/or rotate them. Only the design(s) that are selected will be affected by your changes.



Select All

7. If you want to select all designs, simply touch the select all button. All designs on your screen will be selected, indicated by a design selection frame. You can now make changes to all designs. If you want to combine all the designs into one design, touch the group/ungroup button.



Hoop Selection

The machine will choose the most suitable hoop for the loaded design. To select a different hoop size, touch the hoop selection button. A list will appear with hoop choices, including hoops that are available to purchase from your authorized HUSQVARNA VIKING® retailer.

After selecting your hoop size, the list will close automatically.

Note: You can adjust the list by choosing specific hoops in my hoops in default embroidery settings. The selected hoops will be shown at the top in the hoop selection list.

Note: In the hoop list you will find that some hoop sizes are followed by a letter. These are specialty hoops. For example, E stands for endless hoop, T for texture hoop and M for metal hoop.

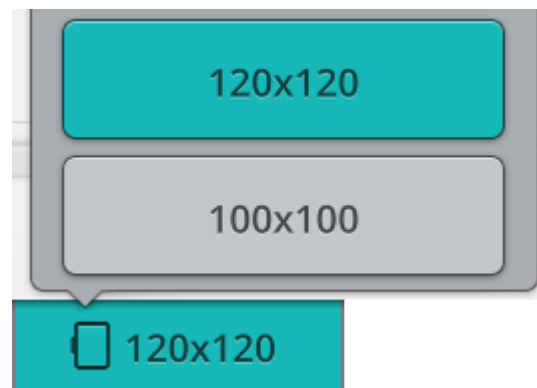

Touch Functions

You can position, rotate, scale and pan directly on the multi-touch screen using your fingers. Touch & hold on a touch function to lock it. This will prevent activation of another touch function by mistake when working with your design(s) directly on the multi-touch screen. Select any touch function to unlock.

Position

Touch and move a selected design with your finger to position it anywhere in the embroidery area. The touch function, position, will automatically be activated.

You can also select the touch function, position, to activate position and use the wheel to adjust the position of the selected design(s). The numbers above the position button show, in millimeters, the horizontal and vertical distance from the center of the hoop for the selected design(s). Touch in the field where the numbers are shown to open a keypad to enter a custom value. If an invalid value is entered, the color of the numbers will change.

Touch the center of the control wheel to position the selected design(s) in the center of the hoop.

Touch & hold on the position button to lock it and prevent activation of another touch function by mistake. A padlock indicates that the function is locked. Select any touch function to unlock.



Touch function pan is locked

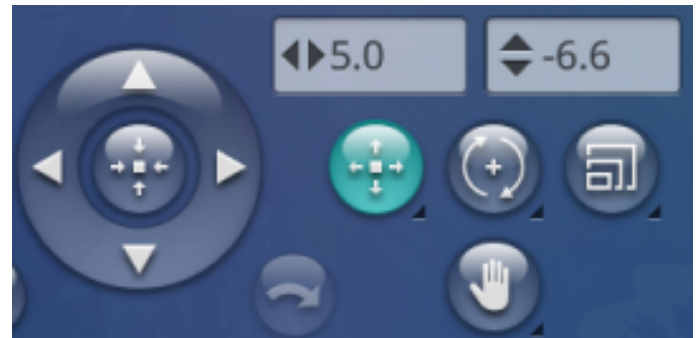

Rotate

Rotate the selected design(s) by touching the rotate handle located in the center of the top of the design selection frame and move your finger on the screen. The touch function, rotate, will automatically be activated.

You can also select the touch function, rotate, to activate rotate and use the arrows in the wheel to adjust the rotation of the selected design(s) in one degree increments. Each touch in the center of the control wheel will rotate the selected design(s) 90 degrees clockwise. The number above the rotate button shows, in degrees, the current rotation angle. Touch in the field where the numbers are shown to open a keypad to enter a custom value. If an invalid value is entered, the color of the numbers will change.

Touch & hold on the rotate button to lock it and prevent activation of another touch function by mistake. A padlock indicates that the function is locked. Select any touch function to unlock.

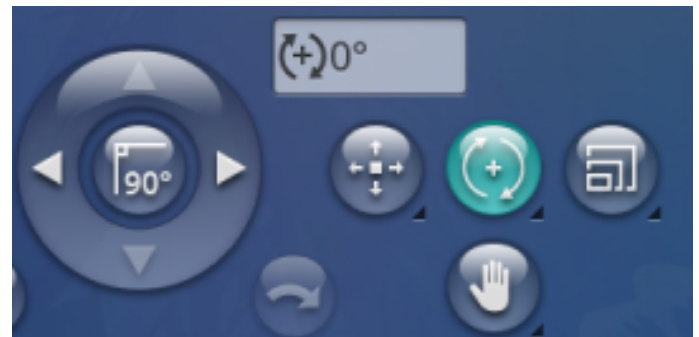

Scale

With the touch function, scale, you can increase or decrease the size of the selected design(s) up to +/- 20% without changing the number of stitches.

Note: To increase or decrease a design more than 20%, use the resize function.

Scale the selected design(s) by touching one of the scale handles in the corners of the design selection frame and move your finger on the screen. The touch function, scale, will automatically be activated. When scaling a design the 100% button will be enabled. Touch the button to scale the design to the default size.

Touch in the field where the numbers are shown to open a keypad to enter a custom value. If an invalid value is entered, the color of the numbers will change.

You can also select the touch function, scale, to activate it and use the arrows in the wheel to adjust the size of the selected design(s). The numbers above the scale button show, in millimeters, the current width and height.

Touch & hold on the scale button to lock it and prevent activation of another touch function by mistake. A padlock indicates that the function is locked. Select any touch function to unlock.

By default the proportions are locked. This is indicated with a closed padlock in the center of the control wheel. Touch the padlock in the center of the control wheel to unlock and activate individual scaling of width and height.

Note: In design shaping and design appliqué the numbers above the touch function scale, relate to the shape line and not the shape/appliqué design.



Pan

Touch and move anywhere in the embroidery area, but not on a selected design, to pan the embroidery area in zoomed view. If you touch and move on a selected design this will activate the position function and you will move the design instead of panning the embroidery area.

Touch & hold to lock pan and prevent activation of position by mistake. A padlock indicates that the function is locked. You can now only pan and zoom. Select any touch function to unlock.

You can also use the control wheel to adjust the view of the embroidery area.

Note: As you zoom in the view of the designs gets very large. Lock the touch function pan and touch and move to pan to a specific part of your design. You can also use the arrows in the control wheel to find the part you wish to work with.

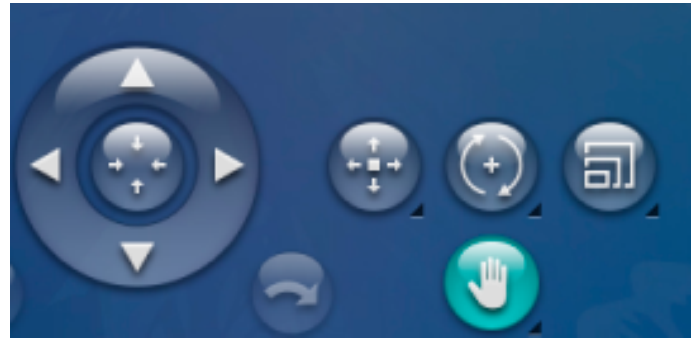

Pan is unlocked



Pan is locked

Zoom

Zoom in by touching with two fingers at the same time on the screen and, without releasing, increase the distance between the fingers to stretch. Zoom out by touching with two fingers at the same time on the screen and, without releasing, reduce the distance between the fingers to pinch.

If you zoom on a selected design, this will might activate the position function and move the design instead of zooming. Touch and hold to lock pan and prevent activating position by mistake. A padlock below the button indicates that the function is locked. You can now only pan and zoom. Select the button again to unlock.

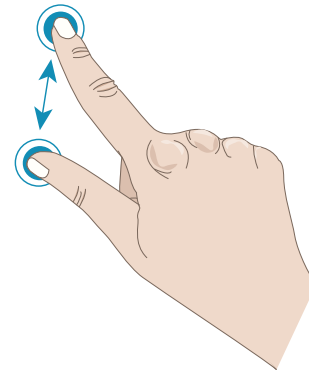

Zoom Options

Touch zoom options to open a pop-up where you choose to use a zoom slider to zoom in and out in the embroidery area, or touch zoom to all or zoom to hoop.

Move the slider to the right to zoom in and to the left to zoom out. You will see how much you have zoomed to the right of the slider.

1. Zoom to all will show all the design(s) in the embroidery combination.
2. Zoom to hoop will zoom to show the whole hoop on the screen.

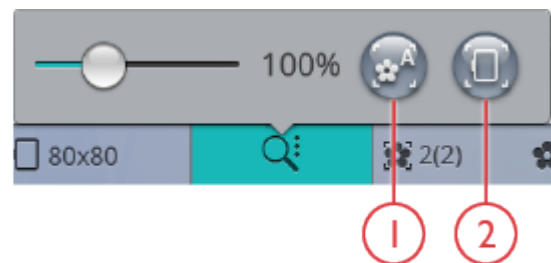

Undo/Redo

Touch the arrow pointing left to undo your latest design adjustment. Touch repeatedly to step back through your adjustments.

Touch the arrow pointing right to redo your latest design adjustment. Touch repeatedly to step forward through your adjustments. Redo is only activated when undo has been touched.

Note: Not all adjustments can be undone. The buttons will be greyed out if undo/redo are not possible.

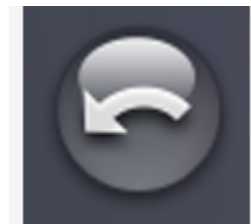

Undo



Redo

Design Stitch Out Order

When working with a design combination that consists of several designs it can be useful to know what order they will stitch out. Select a design to see which stitch out number it is of the total loaded designs. 3(4) for example means that the selected design is the third out of four designs to be stitched out.



Total Number of Stitches in Design Combination

You can see the total stitches in your design combination next to the flower in embroidery edit.



Save Design

To save your file, touch the save button and a pop-up will appear on the screen. In the save pop-up you can choose to save the file to the *mySewnet*TM cloud folder or to a USB device. Previously saved designs, stitches, programs and/or fonts are shown. Name your file with the keyboard and touch the OK button to confirm.

If you want to save to a folder, simply touch & hold on the folder to open it, then name your file with the keyboard and touch OK in the pop-up to save. To create a new folder, simply touch the create new folder button, name the folder with the keyboard and touch OK. Then touch & hold on the folder to open it and save into the new folder.

Touch the list and thumbnail view button to toggle between showing the files in a list or as thumbnail icons. In list view each file is shown with the file name and file type. In thumbnail view each file is shown with file name and a thumbnail image of the file.

To cancel the save process, close the pop-up window by touching cancel. The save pop-up will close and you will return to embroidery mode.

Read more about organizing your saved files in file manager.



Save button in embroidery edit

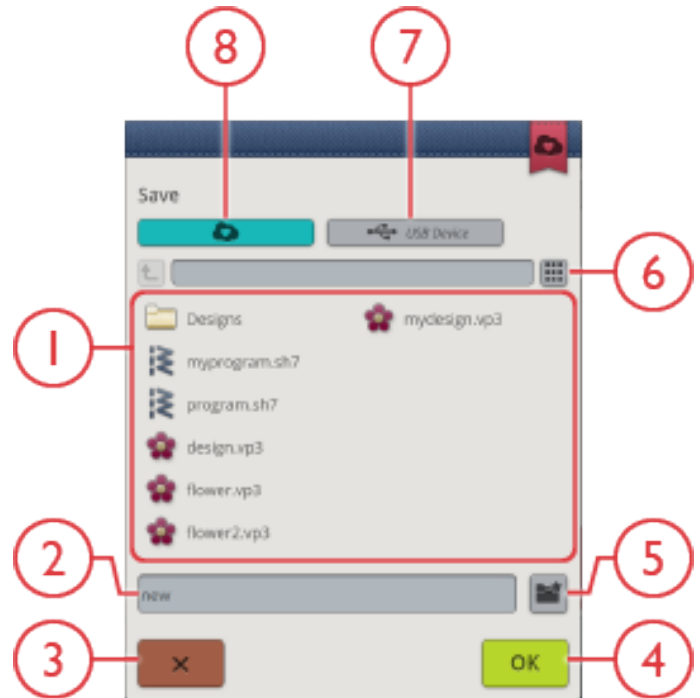

- | | |
|----------------------|---|
| 1. Selection area | 6. Toggle between list and thumbnail view |
| 2. File name | 7. Save to a USB device |
| 3. Cancel | 8. Save to the <i>mySewnet</i> TM cloud folder |
| 4. Confirm | |
| 5. Create new folder | |

Smart Save

If you want to stop sewing and save your current design(s) and settings, touch the smart save button. A pop-up will indicate that a smart save has been done and you can now turn off the machine.

Smart save remembers and stores the stitch, embroidery and settings as they were when smart save was last performed. This makes it possible to turn off your machine and continue sewing later. To load smart save, touch the load smart save button in the JoyOS *advisor*TM feature.

Your smart save will be saved until you touch the smart save button again and replace it.



JoyOS *advisor*TM feature button



Load smart save button

GO

To proceed to embroidery stitch out, touch GO in the lower right corner of the embroidery edit window. When touching GO to enter stitch out, a welcome to embroidery stitch out window will appear. In this window you will get an overview of your current embroidery settings before you continue. Review the settings before you proceed.



Edit an Existing Design or Text

When you have created a design, e.g. a shape, appliqué or text, the edit design button will be active. If you want to edit the design that you have created, select your design and touch the edit design button. Depending on the type of design that is selected, you will enter different windows. For example, if selecting a shaped design, you will enter the design shaping window with the selected design loaded for editing.

Tip: Edit function will also be found in the smart toolbox if available.



Edit Buttonhole

If a buttonhole is selected and the edit button is touched a pop-up appears on the screen. In the pop-up you can change the stitch width, button size and stitch density. Touch the alternative switch bar to change the stitch density. Touch OK in the pop-up to confirm the changes made in the pop-up.

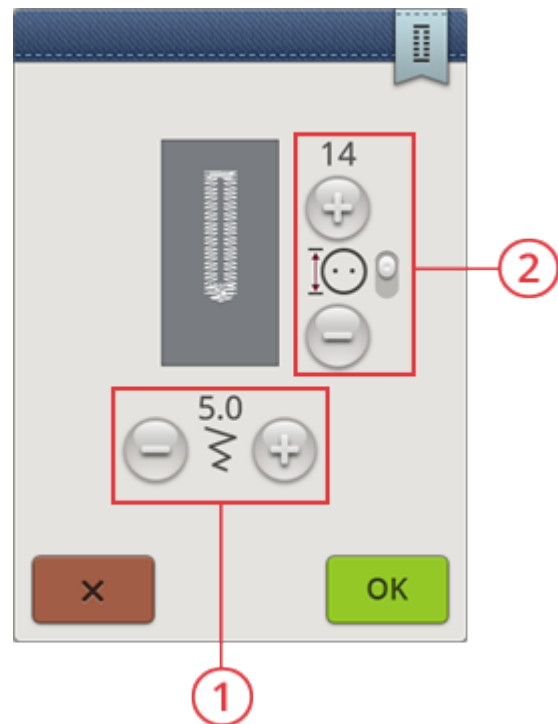

1. Stitch width
2. Button size/stitch density

Thread Color Edit

Touch the thread color edit button to view a list of thread colors in the selected design(s).

Note: Only the color blocks of the selected design(s) will be shown in the thread color edit list.

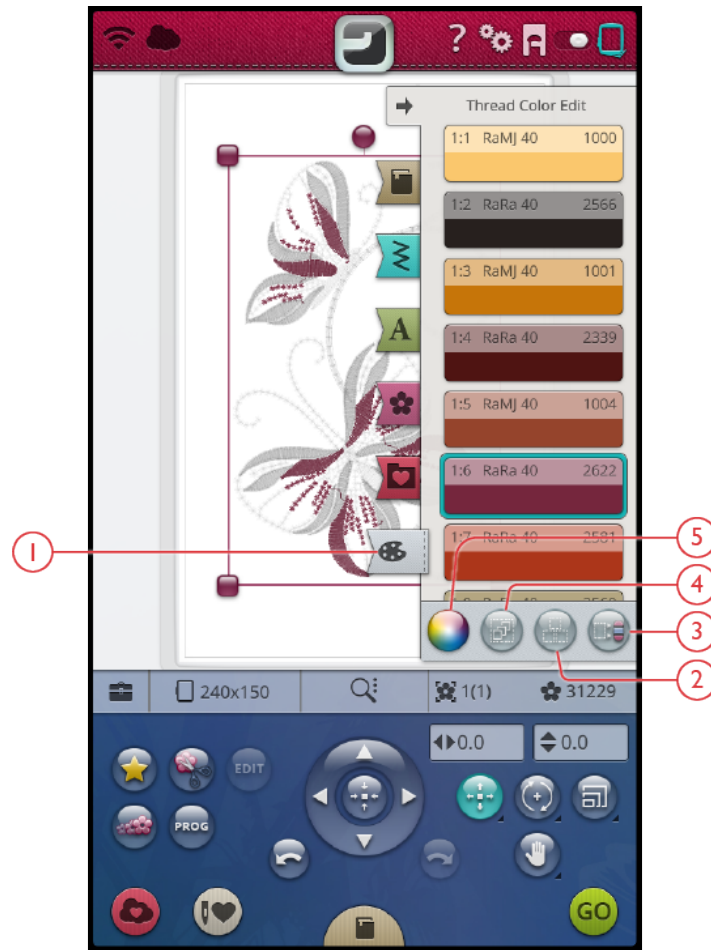

- 1. Thread color edit
- 2. Select all
- 3. Select equal
- 4. Multi-select
- 5. Thread color change

Thread Color Change

You can edit the colors in your design. Each color block is described in the thread color edit list. Touch the color block in the list that you want to change. Touch the thread color change button to open a pop-up where you can select a new thread color.

Touch on the color wheel to select your new color or touch the gray scale bar. When choosing a color from the color wheel a color lightness bar will appear where you can set the lightness of the current color.

Previous selected colors will be shown in squares below the color lightness bar. To select any of the previous colors, touch the color square and it will be shown as the new color.



Pop-up for thread color change

Change More Than One Color Block

To change the thread color on more than one color block at a time, touch the multi-select button, then touch the color blocks to select the ones you want to change.

Touch the select all button to make changes to all color blocks at one time. The multi-select button is automatically selected.

Use the select equal button to change all the same color blocks at one time. Touch the color block you want to change, then touch the select equal button to select all identical color blocks in the list. The multi-select button is automatically selected. If two or more different color blocks are selected, select equal will select all identical color blocks of all of the selected colors.

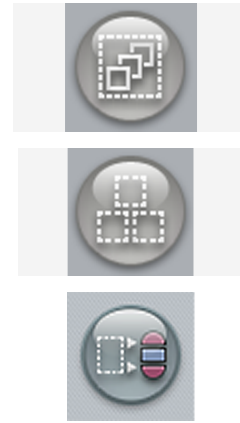

On-Screen Display of Selected and Non-Selected Color Blocks

Selected color blocks are shown with their color on the screen. Color blocks that are not selected will be greyed out in the embroidery area on the screen to make it easy to see which color blocks in the design will be changed.

Touch the selected color block to deselect and show all color blocks in the embroidery area again.

Program Embroidery Text

To create a text design, touch the font menu and select an embroidery font in the selection area. Use the keyboard to write your text and touch OK when finished to load it to the embroidery area.

When selecting an embroidery font the program embroidery text window will open automatically. If you want to adjust an

existing text in embroidery edit, select the text design and touch the edit design button. You can also reach edit via the smart toolbox.

Note: If a stitch font is selected, program will be opened instead when the edit button is touched.



- 1. Text area
- 2. Select spacing
- 3. Select text shape
- 4. Cursor arrows
- 5. Delete
- 6. OK, return to embroidery edit
- 7. Fixed letter angle
- 8. Selected font information
- 9. Selection area

Create a Text

Use the keyboard and touch the letters you want to add to the text. The text is shown in the embroidery area and in the text area above the keyboard.

You can change the font and the size of the entire text by touching another embroidery font in the font menu. The text that is written will change to the new font and/or font size in the embroidery area.

Add a Letter

Use the cursor arrows to move the cursor to where you want to add a letter into a text. Touch the letter and it will be inserted at the cursor position. You can also touch with your finger in the text area to move the cursor.

Delete a Letter

To delete a letter, place the cursor after the letter to be deleted. Touch the delete button. If you want to delete all text that is written, touch & hold the delete button. The letters will be deleted one by one, with increasing speed.

Text Shaping

You can shape your written text with different shaping functions.

Select Text Shape

Touch select text shape to open a list of different shape line types. Touch a shape line and your text will follow the shape line on the screen. The small black arrow indicates the direction your text will follow when adding letters to the shape line.

To change the size of the shape, touch one of the scale handles in the corners of the design selection frame and drag your finger on the screen.



Select Spacing

Touch the select spacing button to open a list of options for spacing your text along the shape line: evenly spaced, left justified, centered or right justified. Evenly spaced will place the text evenly along the shape line with an equal distance between all letters. If you choose left justified the text will begin loading to the left. Centered will center the text on the shape line. If you choose right justified, the text will begin loading to the right. The distance between each letter can be increased or decreased with the spacing slider, except for when evenly spaced is selected.



Fixed Letter Angle

Touch the fixed letter angle button to align all the letters in a fixed, vertical rotation on the shape line. Deselect to angle the letters in relation to the shape line.



Design Shaping

Design shaping is a unique way to take your creativity to another level. Use your beautiful stitch programs or embroidery designs to form one of several shapes.

Tip: Use your JoyOS advisor™ feature to locate JoyOS advisor™ projects for design shaping instructions on how to create a design shape.



Design shaping button

Design Shaping Exercise

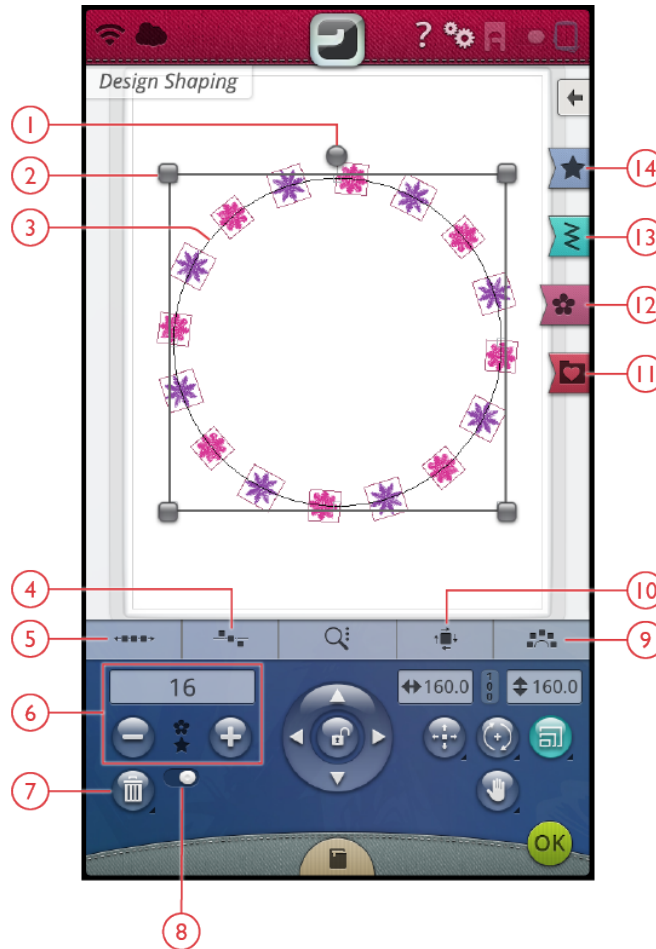

- | | | |
|----------------------------|---|------------------|
| 1. Rotate handle | 6. Set number of designs | 11. File manager |
| 2. Scale handles | 7. Delete last/delete all | 12. Design menu |
| 3. Shape line | 8. Combination repeat/duplicate last design | 13. Stitch menu |
| 4. Select line positioning | 9. Fixed design angle | 14. Shape menu |
| 5. Select spacing | 10. Select side positioning | |

1. Touch the design shaping button in embroidery edit to start a new shape.
2. Touch the shape menu and select one of the shapes in the list. A shape line will be shown on the screen. The small black arrow in the shape menu indicates the direction your designs will follow when adding them onto the shape line.
3. Add designs or stitches onto the shape from the design menu, stitch menu or from file manager. Touch & hold a design or stitch for a few seconds to load and then drag it to the shape line without releasing your finger. Release your finger to place the design or stitch onto the shape line.
4. To change the size of the shape, touch one of the scale handles in the corners of the design selection frame and drag your finger on the screen. The touch function scale will automatically be selected. To rotate your shape, touch and rotate the rotate handle on the multi-touch screen. The touch function rotate will automatically be selected.

Combination Repeat/Duplicate Last Design

5. Add more designs onto your shape in two different ways with the combination repeat/duplicate last design function. When the slider is set to the right, touching the + button will add designs to the shape in the same order as the ones already loaded. When the slider is set to the left, touching the + button will duplicate the last added design in the shape. Touch in the number area above the + and - buttons to open a keypad to set the number of designs.
6. Touch OK in the design shaping window to load the shaped design to the embroidery edit window.



Combination repeat

Duplicate last design

Edit Existing Shape

- If you want to make any changes to an already created shape in embroidery edit, select your shaped design and touch the edit button in embroidery edit. You will now enter the design shaping window again.

Tip: You can also reach edit by opening the smart toolbox. Touch & hold on the shaped design to open smart toolbox.

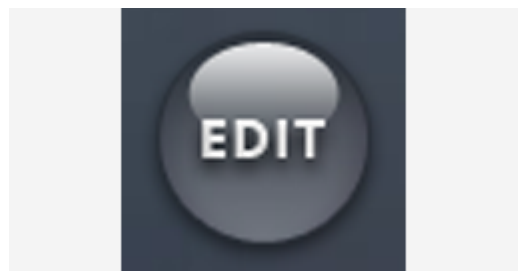

Select Spacing

Touch the select spacing button to open a list of options for spacing your designs along the shape line: evenly space, left justified, centered or right justified. Evenly spaced is selected by default and will place the designs evenly along the shape line with an equal distance between all designs. If you choose left justified the designs will begin loading to the left. Centered will center the designs on the shape line. If you choose right justified, the designs will begin loading to the right. The distance between each design can be increased or decreased with the spacing slider, except for when evenly spaced is selected.



Select Line Positioning

Touch the select line positioning button to open a pop-up with a list of options for placing your designs horizontally, relative to the shape line: above, centered or below.



Select Side Positioning

Touch the select side positioning button to open a pop-up with a list of options for how the designs will be rotated on the shape line: no rotation, rotate 90 degrees clockwise, rotate 180 degrees or rotate 90 degrees counter-clockwise.



Fixed Design Angle

Touch the select design angle to align all the designs in a fixed, vertical rotation on the shape line. Deselect to keep the current angle along the shape line.



Set Number of Designs

If you want to enter the total number of designs you want in your shape, touch in the number area above the + and - buttons to open a keypad. Enter the desired number of designs in the keypad and touch OK to close.

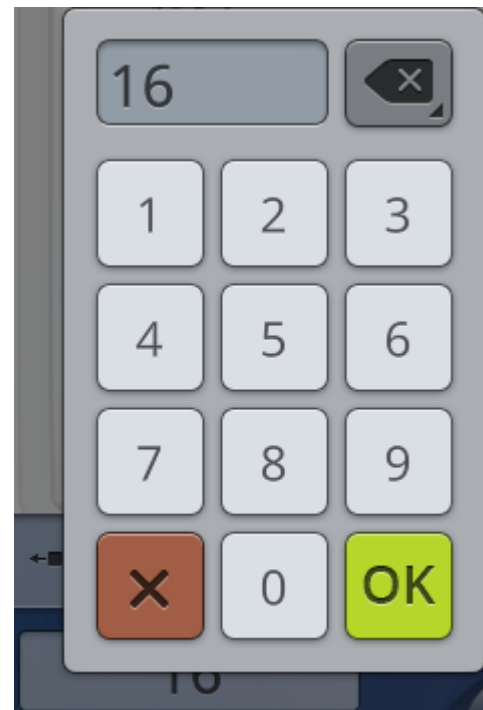

Design Appliqué

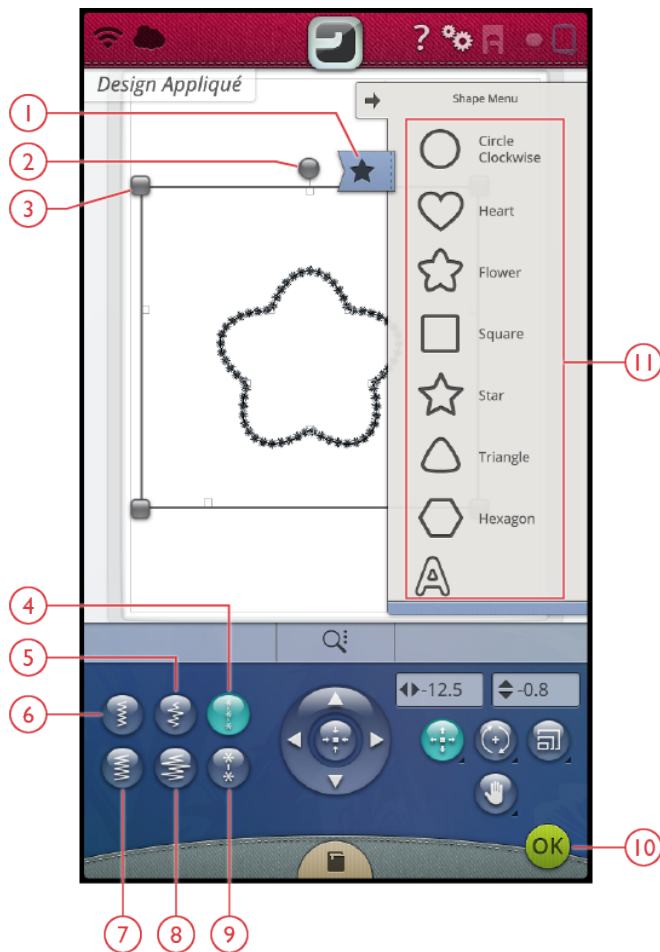

- | | | |
|----------------------------------|------------------------------------|-----------------------------------|
| 1. Shape menu | 5. Feathered satin stitch (narrow) | 9. Candlewicking stitch (wide) |
| 2. Rotate handle | 6. Satin stitch (narrow) | 10. OK, return to embroidery edit |
| 3. Scale handles | 7. Satin stitch (wide) | 11. Selection area |
| 4. Candlewicking stitch (narrow) | 8. Feathered satin stitch (wide) | |

Create a decorative appliqué with the design appliqué feature. Touch the design appliqué button in embroidery edit to start a new appliqué design.

Tip: We recommend to use your JoyOS advisor™ feature for instructions in how to create an appliqué.

When creating your appliqué design there are three different decorative stitches with two different widths to choose from to finish the edge of the appliqué:

- Satin stitch (narrow or wide) – A narrow or wide satin stitch will be placed around your appliqué shape.
- Feathered stitch (narrow or wide) – A narrow or wide feathered stitch will be placed around your appliqué shape.
- Candlewicking stitch (narrow or wide) – A narrow or wide candlewicking stitch will be placed around your appliqué shape.

The decorative stitches will cover the raw edges of the appliqué.

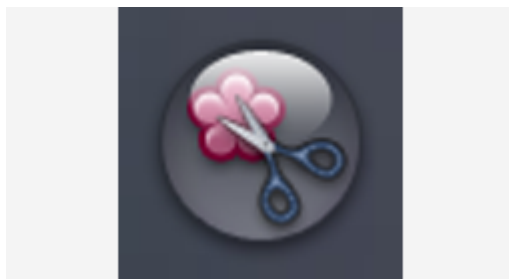

Design appliqué button

Design Appliqué Exercise

1. Touch the design appliqué button in embroidery edit to start a new appliqué. To the right, in the shape menu, you will find different shapes, letters and numbers to choose from when creating your appliqué design. Touch a shape to load it.
2. Touch one of the decorative stitches to load it to the shape line.
3. To change the size of the appliqué design, touch one of the scale handles in the corners of the design selection frame and move your finger on the screen. The touch function scale will automatically be selected. To rotate your shape, touch the rotate handle on the screen. The touch function rotate will automatically be selected.
4. Touch OK to confirm your design appliqué and load to the embroidery edit window. Touch GO to enter embroidery stitch out.

Stitch Out

5. The first color block will sew a straight stitch outline on the base fabric to show where the appliqué will be sewn.
6. Place your appliqué fabric over the outline stitch on the base fabric. Make sure that your appliqué fabric covers the outline.
7. The second color block will sew another straight stitch to secure the appliqué fabric to the base fabric.
8. Trim excess appliqué fabric as close to the stitching line as possible.
9. The stitches in color block three will cover the raw edges of your appliqué.

Resize

Resize can reduce an embroidery design up to five times smaller than the original design or increase it up to eight times larger than the original design. The machine recalculates the number of stitches in the design so the original stitch density remains. Touch the resize button to open the resize window.

Note: To reduce or increase the design less than 20%, use the scale function. The scale function does not change the stitch count.



Resize Adjustments

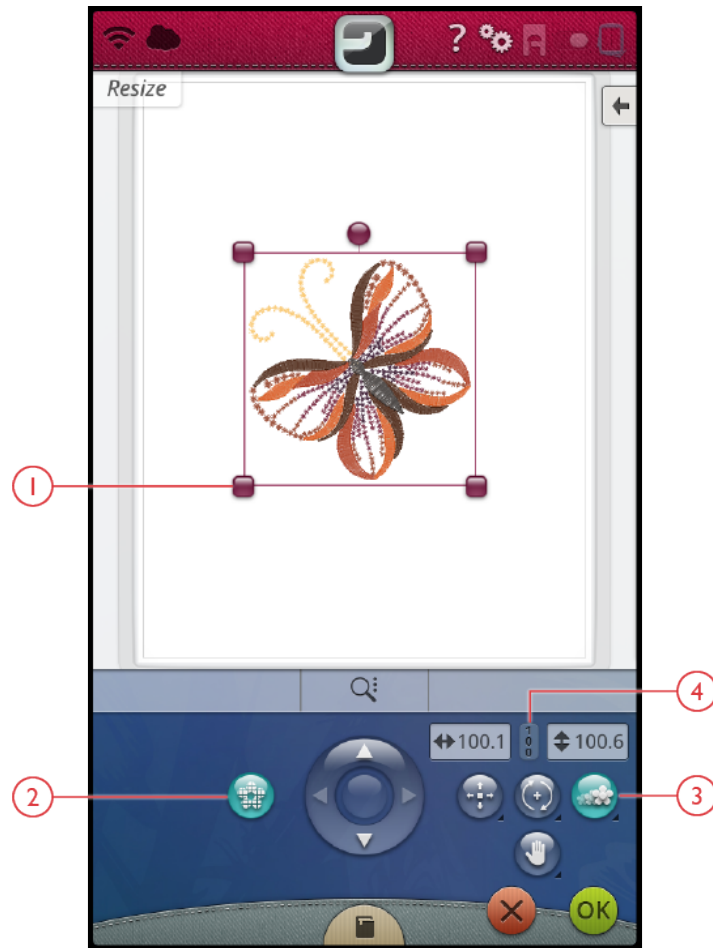

1. Resize handles
2. Retain fill type
3. Resize
4. Return to original size

To change the size of the design, touch one of the resize handles in the corners of the design selection frame and move your finger on the screen. The touch function resize will automatically be selected. When resizing, the height and width of the design are always adjusted proportionally. The numbers above the resize button show the current width and height in millimeters. Fine tune with the control arrows.

When resizing a design the 100% button will be enabled. Touch the button to return to the original size.

Touch & hold the resize button to lock it and prevent activation of another touch function by mistake. A padlock indicates that the function is locked. Select any touch function to unlock.

Adjust the placement of the design in the hoop using position and/or rotate.

Retain Fill Type

All fill areas in an embroidery design are made in a specific fill type to achieve the best results. When enlarging or reducing a design, the stitches in the fill area will be affected. The retain fill type function is selected by default, this will keep the fill types as they were originally created.

Retain fill type gives the best result in most cases. If your design becomes distorted, try resizing without retaining the fill type. Reload the original design, deselect retain fill type and resize your design again.

Start Resizing

When you are satisfied with the design size and position, touch OK. The resize window will close and your resized design is loaded to the embroidery edit window.

Touch cancel to return to embroidery edit without resizing.

Note: Stitches and stitch programs cannot be resized.

Important Resize Information

Since designs are digitized for a specific design size, it is important to consider the following information about resize. Always embroider a test sample of your resized design before embroidering on a project.

- | |
|---|
| <ul style="list-style-type: none">• Resize is always proportional. If you reduce a design 30%, it will be 30% smaller in both length and width. If the design is very detailed, some of it may be lost or distorted, and/or it can become very dense. Some designs, especially those with lots of detail, should not be reduced more than 25%. |
| <ul style="list-style-type: none">• Designs can be resized larger than the selected hoop. After resizing, make sure the design fits or select a larger hoop for the machine to be able to embroider it. |
| <ul style="list-style-type: none">• If you enlarge a design too much, you may see stitch irregularities. Press the 100% button to return to original size and resize to a smaller percentage for a better result. Please use the embroidery software (PC) to resize very large and complex designs. It is available to purchase from your local authorized retailer. |
| <ul style="list-style-type: none">• Always start with the original design when resizing. This is to ensure the best possible stitch quality. If a resized design is saved, and then resized again, it can cause stitch irregularities. |
| <ul style="list-style-type: none">• It does not matter in which order you select functions to adjust the size, position and rotation. When you touch OK, your machine always resizes first and then adds the other adjustments. |
| <ul style="list-style-type: none">• It is recommended that you scale instead of resize to change a design less than 20%. Scale is also recommended for designs digitized with single or triple stitches, such as cross stitch embroideries. In this case, you do not want to add stitches to the design, you only want to make the design larger or smaller by making each original stitch larger or smaller. |

Embroidery Edit Pop-up Messages

The Maximum Number of Stitches Has Been Reached

The design combination you are trying to make contains too many stitches. Your design combination can have a maximum of approximately 500,000 stitches.

The Embroidery Combination is too Complex

This pop-up message appears e.g. for one of the following reasons:

- The design combination contains too many color blocks.
- There are too many designs in the combination.
- One or more designs have been grouped and re-grouped too many times.



9 Embroidery Stitch Out

Embroidery Stitch Out – Overview

To embroider your design(s), enter embroidery stitch out by touching the GO button in embroidery edit. Before entering embroidery stitch out you will see a welcome to embroidery stitch out window with your current embroidery settings.

Review your settings, make any necessary changes, then touch continue to enter embroidery stitch out. The embroidery unit needs to be connected in order to enter embroidery stitch out. Attach the correct hoop once you are in embroidery stitch out.

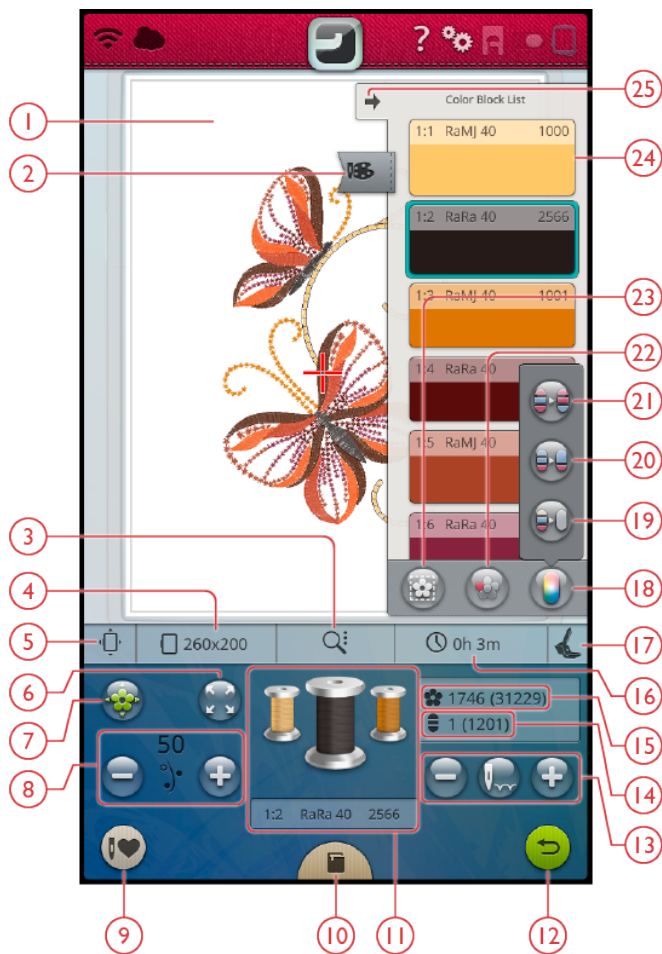

- | | | |
|-------------------------------------|--|--------------------------------------|
| 1. Embroidery area | 10. JoyOS <i>advisor</i> TM project viewer | 17. Selected embroidery foot type |
| 2. Color block menu | 11. Thread color spools | 18. Color options |
| 3. Zoom options | 12. Return to embroidery edit | 19. Monochrome |
| 4. Selected hoop | 13. Step stitch-by-stitch/Go to stitch | 20. Color block merge |
| 5. Hoop position options | 14. Number of stitches in current color block | 21. Color block sort |
| 6. Corner check | 15. Total number of stitches in embroidery combination | 22. Highlight current color block |
| 7. Design positioning | 16. Remaining embroidery time by color block | 23. Basting options |
| 8. Thread portioning/Thread tension | | 24. Color block |
| 9. Smart save | | 25. Minimize/expand color block list |

Welcome to Embroidery Stitch Out

Before you enter embroidery stitch out mode, a welcome to embroidery stitch out window will appear. In this window you will see an overview of your current embroidery settings. Review your current embroidery settings to check that everything is set as you desire.

Touch continue in the lower right corner to proceed to embroidery stitch out. Touch return to go back to embroidery edit.

Attached Needle Plate

The Straight Stitch Plate is generally recommended for best results in embroidery. Your DESIGNER BRILLIANCE™ 80 machine senses which needle plate is attached. If the needle plate shown is not the one you wish to use, attach your preferred needle plate. Read about how to change to the Straight Stitch Plate.

Selected Hoop

The currently selected hoop in embroidery edit is shown in the window. If you want to change the hoop, touch return to go back to embroidery edit. There you can change the hoop in hoop selection. When you attach a hoop, the machine will sense which hoop that is attached to confirm that the hoop attached is the selected hoop in embroidery edit.

Color Options

Preset your embroidery with any of the three color options: color block sort, color block merge or monochrome. You can also set these options in embroidery stitch out. Read more about color block sort, color block merge or monochrome.

Note: You can set both color block sort and color block merge if desired.

Basting Options

Select basting to add a basting stitch that will secure your fabric to your stabilizer. You can choose either baste around design or baste around hoop or both. Basting can also be activated in embroidery stitch out. Read more about basting options.

Selected Embroidery Foot Type

Select which embroidery foot type you will use for the embroidery. The Sensor Q-Foot and *deLuxe*™ stitch system are recommended for best embroidery results. Whichever foot type you have selected in the temporary embroidery settings is the foot that will be shown in this window. You can change the foot type in the window and it will change the selected embroidery foot type in the temporary embroidery settings.

deLuxe™ Stitch System

Depending on which embroidery foot is selected in temporary embroidery settings the *deLuxe™* stitch system will be enabled/disabled. Embroidering with the *deLuxe™* stitch system and the Sensor Q-Foot is recommended for best embroidery results. Read more about the *deLuxe™* stitch system.

Thread Cut Options

Any settings for the thread cut options made in temporary embroidery settings will be shown in the window. You can also change the thread cut options in the window.

Turnable Hoop – Side Sort

This option will only be visible if the DESIGNER™ Majestic Hoop 360x350 is chosen in the hoop selection list in embroidery edit. If you want to embroider all designs on one side of the DESIGNER™ Majestic Hoop before you turn the hoop, select the side sort option before touching continue.

Color Block List

All colors in the loaded design(s) are shown in the order they will be embroidered. Each listed color shows the design number and color block order. Also shown are the thread manufacturer, thread weight and thread color number. The size of each color block gives an indication of how many stitches the color block contains.

Swipe down to scroll in the color block list to see all of the color blocks. The same information will be shown for the active color block in the thread color spools on the screen. To go to another color block, touch a color block in the color block list or swipe with your finger over the thread color spool to activate the next or previous color block in the color block list.

Example: 1:2 RaRa 40 2254, means the second thread color block in the first design to be embroidered is Robison-Anton Rayon 40 weight thread, number 2254.

If you want to minimize the color block list, touch the minimize/expand button at the top left corner or touch the color block menu button.



Zoom

Zoom in by touching with two fingers at the same time on the screen and, without releasing, increase the distance between the fingers to stretch. Zoom out by touching with two fingers at the same time on the screen and, without releasing, reduce the distance between the fingers to pinch.

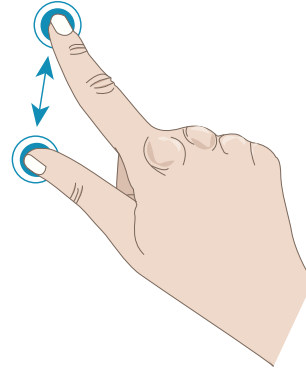

Zoom Options

Touch zoom options to open a pop-up where you choose to use a zoom slider to zoom in and out in the embroidery area, or touch zoom to all or zoom to hoop.

Move the slider to the right to zoom in and to the left to zoom out. You will see how much you have zoomed to the right of the slider.

1. Zoom to all will show all the design(s) in the embroidery combination.
2. Zoom to hoop will zoom to show the whole hoop on the screen.

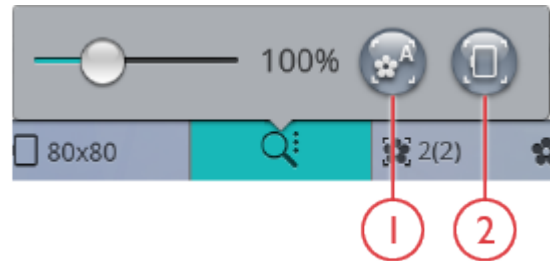

Corner Check

Use corner check to trace the four corners of the design to see where the design will be stitched out on the fabric.

Each touch on the corner check button will move the hoop to the following positions and in the following order: upper left, upper right, lower right, lower left and then go back to the current stitch position.



Hoop Position Options

Use the hoop position options to move the embroidery arm to different positions.

Current Stitch Position

When you want to return to the current stitch position and continue embroidering after you have changed the hoop position, touch the current stitch position. You can also press the start/stop button once to return to the current stitch position and start the embroidery.



Park Position

Use the park position when you want to move the embroidery arm out of the way or when you want to pack the embroidery unit in the carrying bag.



Note: Normally the embroidery unit is in park position when in embroidery edit or sewing mode.

Trim Position

Trim position will move the hoop towards you, making it easier to trim threads and fabric for specialty techniques.

Tip: You can also use the needle up/down button on your machine as a shortcut to move the hoop to trim position.



Center/Remove Hoop Position

When you need to remove the hoop, e.g. when changing a bobbin, touch the center/remove hoop position. This will also show the center position of the hoop.

Tip: You can also use the stitch re-start button on your machine as a shortcut to move the hoop to center/remove hoop position.



Design Positioning

Use the design positioning feature to place a design on an exact location on your fabric without re-hooping. It can also be useful when you want to embroider a design to exactly match a specific spot on your project or next to a previously embroidered design.

Touch the design positioning button to open the design positioning window.



To move your design in the hoop without selecting a specific locking point, touch and move your design until you are satisfied with the placement. You can also open the toolbox and touch the set cursor point center button to quickly find the center of your design and move the design to the center of your hoop if needed.

Tip: If you just want to move your embroidery in the hoop, open design positioning and move your design with your finger on the screen or use the control wheel.

Zoom the embroidery area to be sure that you are placing the design exactly where you want it by touching the zoom options and using the zoom slider or the zoom to cursor button. You will see how much you have zoomed to the right of the slider.

You can also use the pinch/stretch function to zoom in and out.

Zoom to Cursor

Touch the zoom options button to find zoom to cursor. When using the zoom to cursor it will maximize the zoom and pan the embroidery area so the cursor position is centered on the screen.



Set Cursor Point

Open the toolbox to find the set cursor point buttons. Move the cursor point to any of the selected corners or to the center of the design. The set cursor point can be used to trace the design field by touching each of the four corner buttons. Find the center of the design by touching the set cursor point center button.



Position and Rotate a Design

In this exercise you will learn how to position a design using two connection points.

Stitch to stitch accuracy is achieved by locking in on one connection point and rotating around that point to ensure that the second connection point is also perfectly aligned.

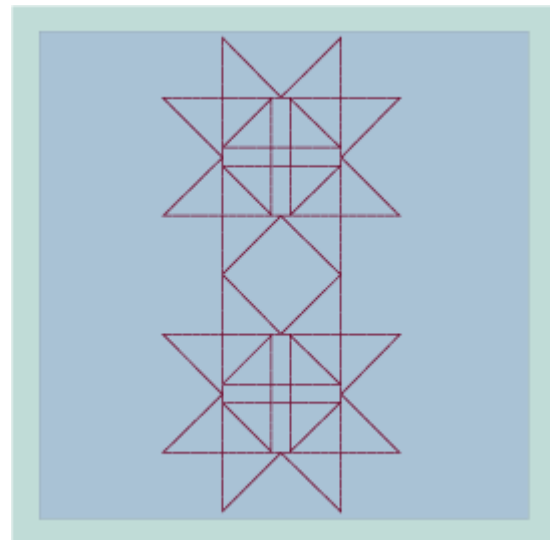

1. Embroider design #3 in the Quilt Designs menu E.
Remove the hoop from the embroidery unit and the fabric from the hoop.

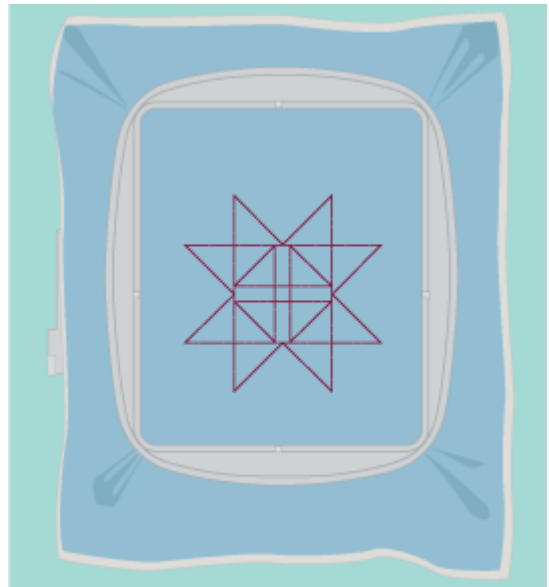

2. Rehoop the fabric and stabilizer so that there is room for the new design to stitch, making sure that the connection point of the previously stitched design is within the embroidery area.

Attach the hoop to the embroidery unit arm.

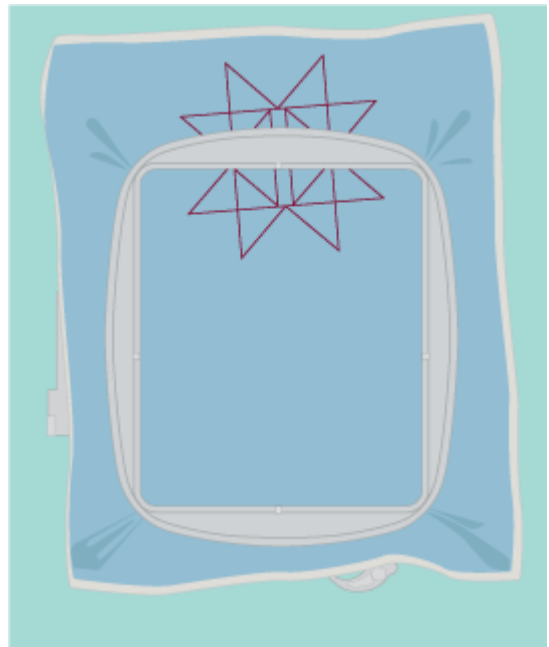

3. Choose a point on the new design that you want to match/connect to the previously embroidered design.

Touch the design positioning button to open the design positioning window. Select Step 1 and set the cursor to the point in the design on the screen that you want to connect to a point on the design on your fabric.



4. Open zoom options and select zoom to cursor.



5. Select step 2 to set the locking point.



6. Move the hoop by touching the arrows on the wheel or dragging on the screen until the needle is exactly above the connection point in your embroidered design.

Turn the hand wheel towards you to check the exact position of the needle. Use the wheel to fine tune if necessary.

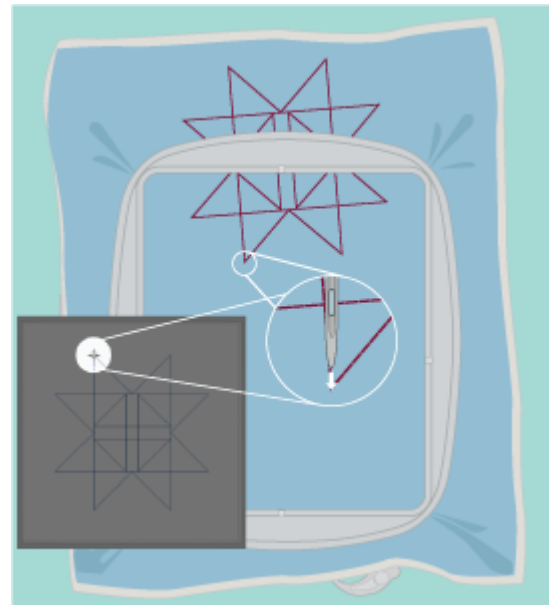

7. Select Step 3 and set the blue cursor to a second point in the design on the screen that you want to connect to a point on the design on the fabric.

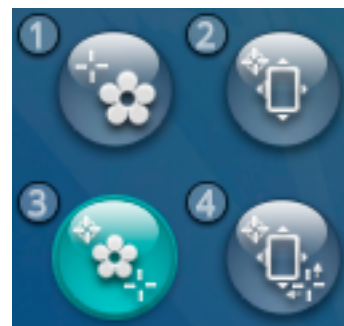

8. Open zoom options and select zoom to cursor.

9. Make sure the cursor is placed exactly where you want it. Fine tune with the wheel.



10. Select step 4 to verify the position of your second connection point.

- If the needle is exactly above the second connection point in the design on the fabric, touch OK to confirm your adjustments and return to embroidery stitch out.
- If not, use the arrows on the wheel to rotate the design on your screen. The hoop will move beneath the needle.

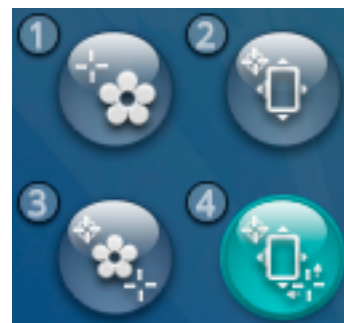

11. When the needle is directly above the second connection point in the design on the fabric, touch OK to confirm your adjustments and return to embroidery stitch out.

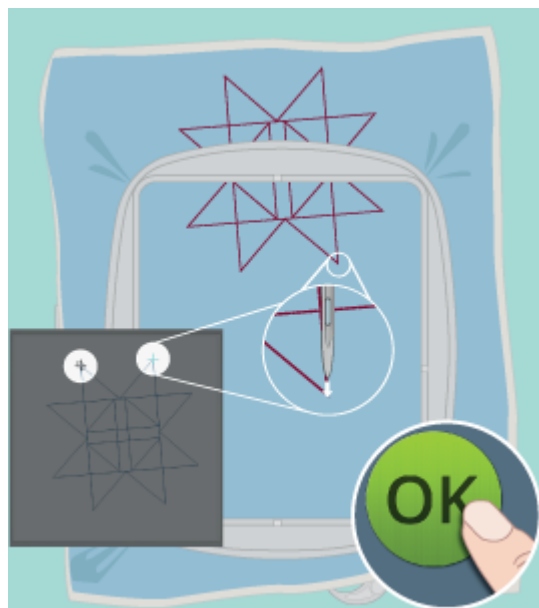

12. Embroider the design again. Once the embroidery is finished touch OK in the pop-up. You can now rehoop and repeat the pattern as many times as you wish.

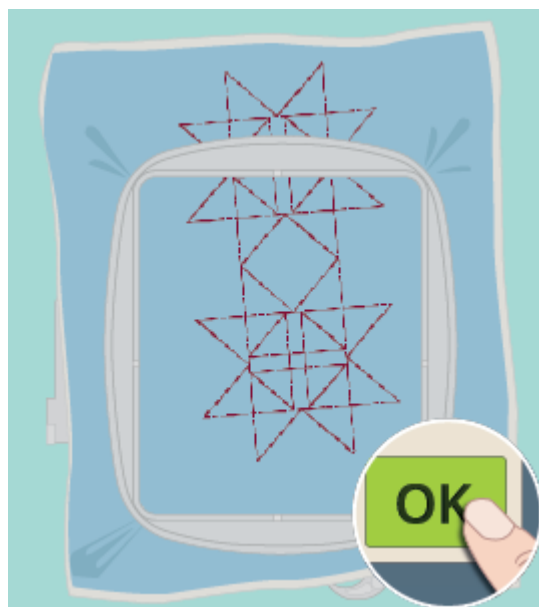

deLuxe™ Stitch System

The control visible in embroidery stitch out will change depending on whether the *deLuxe™* stitch system is active or not in the temporary embroidery settings. Use the controls to adjust the balance between upper thread and bobbin thread, e.g. when embroidering with specialty thread. Read more about the *deLuxe™* stitch system in temporary embroidery settings.

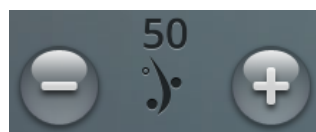

Thread portioning

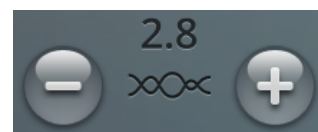

Thread tension

Smart Save

If you want to save your work, including loaded stitch, loaded embroidery, current stitch position and settings, touch the smart save button. A pop-up will indicate that a smart save has been done and you can now turn off the machine or start a new JoyOS *advisor™* project. Smart save remembers and stores all your design and stitch adjustments along with your settings. This makes it possible to continue your work later.



To load the last performed smart save, touch the load smart save button in the JoyOS advisor™ feature.

Note: When you touch smart save the previously saved smart save will be deleted.



JoyOS advisor™ feature button



Load smart save button

Auto Smart Save

When embroidering your DESIGNER BRILLIANCE™ 80 machine will continuously and automatically save your ongoing work, including the loaded stitch, embroidery, current stitch position and settings. If there is a power outage when you are in embroidery stitch out a pop-up will appear when your machine is restarted. In the pop-up you can choose to return to embroidery stitch out and bring up the design ready to stitch. The embroidery will start from approximately the same position as it was interrupted from.

Tip: Before starting the embroidery go back a few stitches using the step stitch-by-stitch control to ensure that the threads will be secured.

Thread Color Spools

All colors in the loaded design(s) are shown in the order they will be embroidered in thread color spools. Underneath the current thread color spool, information about the design number and color order is shown. Also shown are the thread manufacturer, thread weight and color number. Swipe left or right on the thread color spools to activate the next or previous color block in the color block list.

While embroidering, the shade of the active thread color spool will fade indicating how much of the color block is left to embroider.

Example: 1:2 RaRa 40 2254, means the second thread color in the first design to be embroidered is Robison-Anton Rayon 40 weight thread, number 2254.



Return to Embroidery Edit

Touch the return button to return to embroidery edit where you can adjust your design(s).



Step Stitch-by-Stitch/Go to Stitch

Touch + to step forward and - to step backwards stitch by stitch. Move backwards a few stitches, e.g. after the upper thread breaks or runs out, to ensure that the thread will be secured. Touch & hold to move through the stitches more rapidly. The cursor on the screen will follow the stitches in the embroidery area.

To go to a particular stitch within the color block, touch the go to stitch button. A keypad will open, where you can enter the stitch number. If the number entered is too large, the machine will move to the last stitch in the current color block.



Number of Stitches in Current Color Block

The current stitch position in the current color block is shown next to the color block icon. The number in brackets shows the total number of stitches in the current color block.

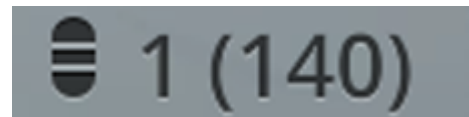

Number of Stitches in Embroidery Combination

The current stitch position in embroidery combination is shown next to the flower icon. The numbers in brackets shows the total number of stitches in the design or combination.



Remaining Embroidery Time by Color Block

An estimation of the remaining embroidery time for the current color block is shown in hours and minutes next to the clock icon. If monochrome is activated, the estimated remaining embroidery time for the whole embroidery combination is shown.

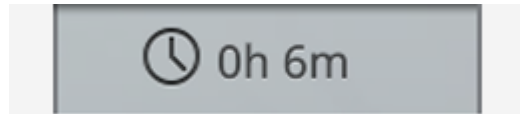

Color Options

Use the color options to stitch your design easier and faster.

Touch the color options button to open a list of buttons for the available options.



Color Block Sort

Color block sort intelligently sorts all color blocks so that the blocks with the same color will follow each other in the color block list.

Note: Color block sort has to be performed before you start to embroider. Once you have started to embroider the color block sort button will be greyed out.



Color block sort button



Color block merge button



Monochrome button

Color Block Merge

Activate color block merge to eliminate the stops between identical color blocks.

Note: The appearance of the color block list will remain the same.

Monochrome

Touch the button to activate monochrome embroidery. All designs are shown in a grey color and the machine will not stop for color block changes. To deactivate monochrome embroidery, touch the button again.

Note: If the automatic thread cutter and automatic jump stitch trim function is selected in temporary embroidery settings the jump stitches will still be trimmed between the color blocks.

Tip: You can also touch the STOP function on your machine as a shortcut to activate monochrome.

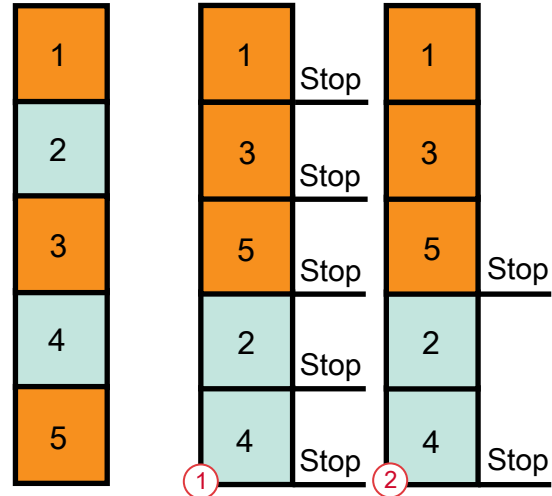

1. Color block sort
2. Color block sort and color block merge

Highlight Current Color Block

Touch the button and only the color block that is currently stitching will be visible in the embroidery area. All other color blocks will be greyed out.

Highlight current color block can be useful when your design contains color blocks in different shades of the same color, especially if they are close to or overlapping each other.

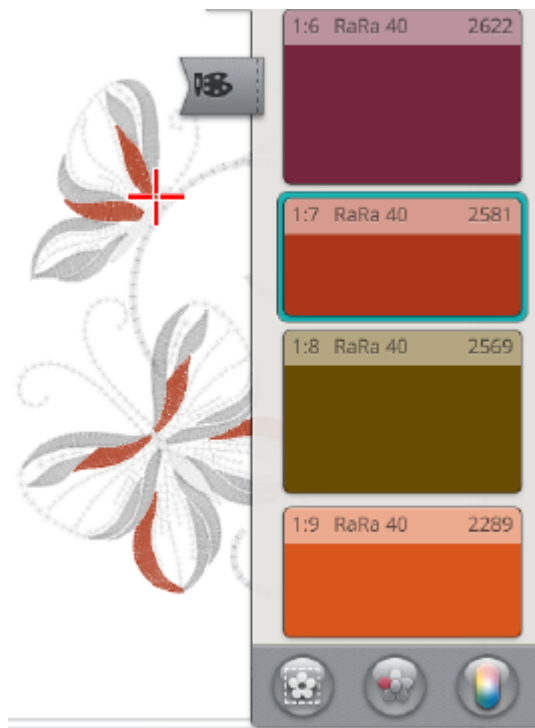

Basting Options

Basting enables you to secure your fabric to a hooped stabilizer. It is especially useful when the fabric that is going to be embroidered cannot be hooped. Basting provides support for stretchy fabrics.

Touch the basting options button to open the embroidery basting options pop-up. The basting options can also be set in the welcome to embroidery stitch out window before entering embroidery stitch out.

Touch baste around design to add a basting stitch around the design, outlining the area where the design will be placed on the fabric.

Touch baste around hoop area to add a basting stitch around the inside edge of the hoop.

You can select both basting options to add additional support for certain fabrics and techniques.

Note: When activated only the basting color blocks will be shown in the color block list. When basting is complete the color block list will once again show the color blocks of your design.

Tip: Touch the FIX function on your machine to activate baste around design.



Basting options button

Embroidery Stitch Out Pop-up Messages

The Embroidery Arm Needs to Calibrate

When the embroidery unit is attached, a pop-up message will appear and inform you to slide off the hoop and clear the machine area for calibrating the embroidery arm. You will also be reminded to attach a suitable embroidery foot.



It is very important to remove the hoop, otherwise the hoop or the embroidery unit may be damaged while calibrating.

Attach Hoop

If the hoop attached to the machine does not match the hoop that is selected and displayed on the screen, the machine will not embroider. You must change the hoop to the one displayed on the screen or return to embroidery edit and select the hoop to match the attached hoop.

The hoop needs to be inserted properly for the machine to detect it. Slide the hoop connector into the hoop attachment from front to back until it clicks into place.

The Bobbin Thread is Running Low

When the bobbin thread is running low, a pop-up message appears giving you advance notice that you will soon need to change the bobbin. This gives you an opportunity to plan when you want to change your bobbin.

It is possible to embroider until the thread has completely run out. Without closing the pop-up, touch the start/stop button, or the foot control, to continue embroidering.

Touch cancel to remain at the current stitch position.

Touch OK to move the hoop to the center/remove hoop position. The hoop position pop-up opens. Replace the empty bobbin with a full one. Touch current position in the pop-up and pull back any excess length of needle thread. Touch the start/stop button to continue embroidering.

Check Upper Thread

The machine stops automatically if the upper thread runs out or breaks. Re-thread the upper thread from the beginning, close the pop-up message and then go back a few stitches using the step stitch-by-stitch control to ensure that the thread will be secured. Re-start your embroidery.

Change Thread

When it is time to change the upper thread, the machine will stop. Change the spool of thread and re-thread the machine. The recommended thread color number is shown in the pop-up message.

Cut and Remove the Thread Tail

After changing the thread, the machine will sew a few stitches and then stop so you can cut the thread tail.

Note: When automatic thread cutter and automatic jump stitch trim function is selected in temporary embroidery settings, the thread will be cut automatically and no cut thread tail pop-up will be shown. Simply remove the thread tail that has been cut.

Your Embroidery is Finished

A pop-up message and sound informs you that your embroidery is finished. When the pop-up is closed the design will stay loaded in embroidery stitch out and you can stitch the same embroidery again, including any changes you have made.

Your Embroidery Ended Unexpectedly.

Do You Want to Resume the Embroidery? (Auto Smart Save)

If a power outage has occurred, you will see this pop-up message when the machine is restarted. Touch OK in the pop-up to return to embroidery stitch out. This will load the design ready to stitch from approximately the same position it was interrupted.

Tip: Before starting the embroidery go back a few stitches using the step stitch-by-stitch control to ensure that the threads will be secured.

Change Needle (Optional Accessory)

Cutwork designs and felting designs require special optional needle accessories. Cutwork designs require the HUSQVARNA VIKING® Embroidery Cutwork Needle Kit (920268-096) and felting designs require the HUSQVARNA VIKING® Felting Embroidery Set (920402-096).

When the machine stops and this pop-up message is shown, insert the corresponding optional needle. Touch OK and press the start/stop button to resume.

Cutwork designs are marked with a cutwork needle symbol and felting designs are marked with a felting needle symbol in the DESIGNER BRILLIANCE™ 80 Sampler book.

Note: Cutwork designs can also be stitched out without using the cutwork needles. The cutwork area will then have to be cut manually and the color block for the cutwork needle in the color block list should be skipped.

Attention!

If the machine stops and this pop-up appears on the screen you cannot continue embroidering. Wait a moment and touch OK when it is enabled. Check needle size and condition and check that your machine is threaded correctly.



I0 Program

Program – Overview

You can combine stitches and/or letters and numbers to create stitch programs. Combine various decorative stitches and stitch fonts from the *mySewnet*™ cloud folder on the machine or from a USB device.

You can combine program stitches up to approximately 500 mm (20”) long. You can see how long your stitch program is

at the top of the window. You can program in both sewing and in embroidery edit.

Tip: If sewing mode is active and your stitch program is ready to be sewn, you can close the program window by pressing the foot control, or by pressing the start/stop button.

Note: Not all stitches are available to program. A pop-up message will alert you if you try to select an unavailable stitch.

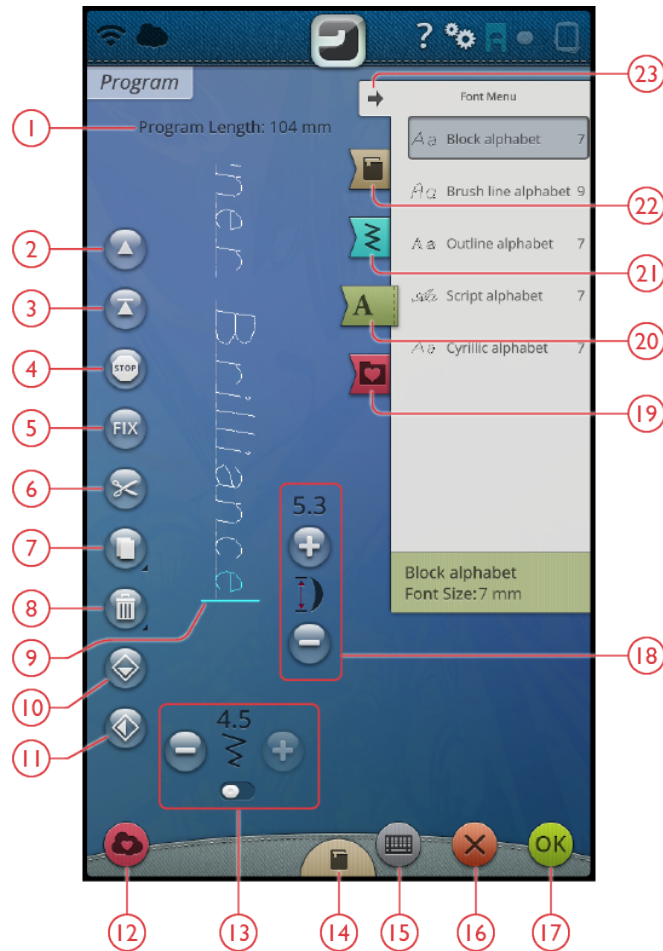

1. Program length
2. Step to previous stitch/go to last
3. Step to next stitch/go to first
4. STOP command
5. FIX command
6. Thread cut command
7. Duplicate
8. Delete

9. Cursor
10. Mirror end to end
11. Mirror side to side
12. Save
13. Stitch width/Stitch positioning
14. JoyOS *advisor*™ project viewer
15. Open keyboard
16. Cancel program

17. OK, return to sewing mode
18. Stitch length/Stitch density
19. File manager
20. Font menu
21. Stitch menu
22. JoyOS *advisor*™ project menu
23. Minimize/expand selection area

Create New Program

1. To create a new program, touch the program button to open the program window.



2. Touch the stitch menu or font menu to select the stitch or a font you want to use.



Stitch menu



Font menu

3. Insert stitches from file manager or the stitch menu. The active position is shown with a cursor and the stitch or letter is highlighted. Inserted stitches or letters will be selected and placed at the cursor. Only the selected stitch or letter can be adjusted. You can move the cursor through the stitch program by using the step to previous stitch/step to next stitch arrows.

Note: A straight line at the point of the arrows indicates go to last/go to first stitch.

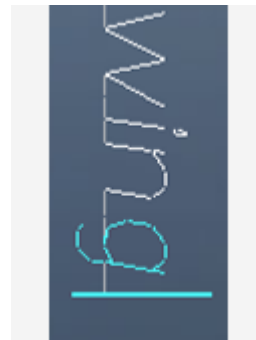

Active position is highlighted



Step to previous stitch/step to next stitch

4. When the font menu is selected the keyboard is opened automatically to write your text. Minimize the keyboard by touching the top right corner to be able to access the OK button.

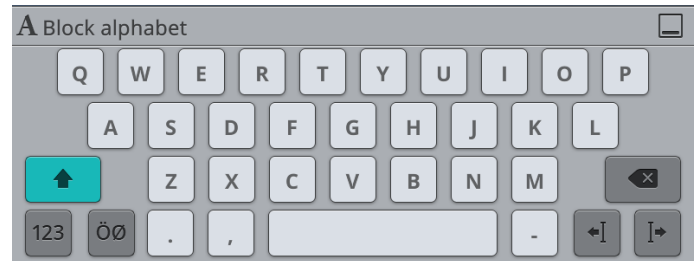

5. Touch the OK button to load your program to sewing mode. Alternatively load your program by pressing down the foot control or touch the start/stop button on your machine. Touch cancel to undo your program and close the program window.

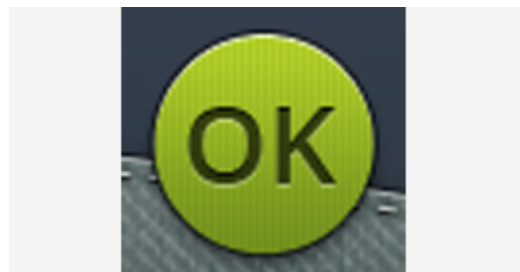

To Edit a Created Program

If you want to edit an already loaded program in sewing mode, touch the edit stitch program button and you will enter the program window again. Alternatively, touch & hold on the program to open the smart toolbox to access the edit button. Make your adjustments and touch OK in the program window to load it to sewing mode with your adjustments. Touch the cancel button in program to undo.



Edit Stitch or Lettering Program

Insert a Stitch or Letter

Move the cursor to the point where you want to add a stitch or letter by using the step to previous/step to next stitch button. If the step to previous arrow has an underline you will move the cursor to the beginning. If the step to next arrow has an underline you will move the cursor to the end. Touch the desired stitch in the stitch menu or in file manager to add it at the cursor position.

Touch the font menu to open a keyboard and touch a letter to insert it at the cursor. Change the font style by touching another font style in the selection area. Close the keyboard at the top right corner. If you touch the stitch menu or file manager the keyboard will close automatically. You can open the keyboard again by touching the keyboard button or touching the font menu.

Adjust a Stitch or Letter

You can mirror, adjust the length, width and position or change the density of the selected stitch, in the same way you can adjust the stitch settings in sewing mode.

Touch & hold over the program on the screen to open the smart toolbox. The smart toolbox will allow you to duplicate, delete or mirror the selected stitch or letter in the program.

Delete a Stitch or Letter

If you want to delete a stitch, move the cursor to the stitch or letter you want to delete (the selected stitch or letter will be blue) and touch the delete button on the screen or in the smart toolbox. Touch & hold the delete button to delete the entire program.

Duplicate a Stitch or Letter

To duplicate a stitch, move the cursor to the stitch or letter you want to duplicate (the selected stitch or letter will be blue) and touch the duplicate button on the screen or in the smart toolbox.

Note: Make your adjustments to the stitch before duplicating and the duplicated stitch will include the adjustments.

Touch & hold to use the keypad where you can enter the exact number of copies you want to insert.

Replace a Stitch or Letter

To replace a stitch or letter, simply select it using the scroll arrows to select the stitch or letter you wish to replace and touch delete. Insert the new stitch or letter and it will be placed at the cursor.



Keyboard button

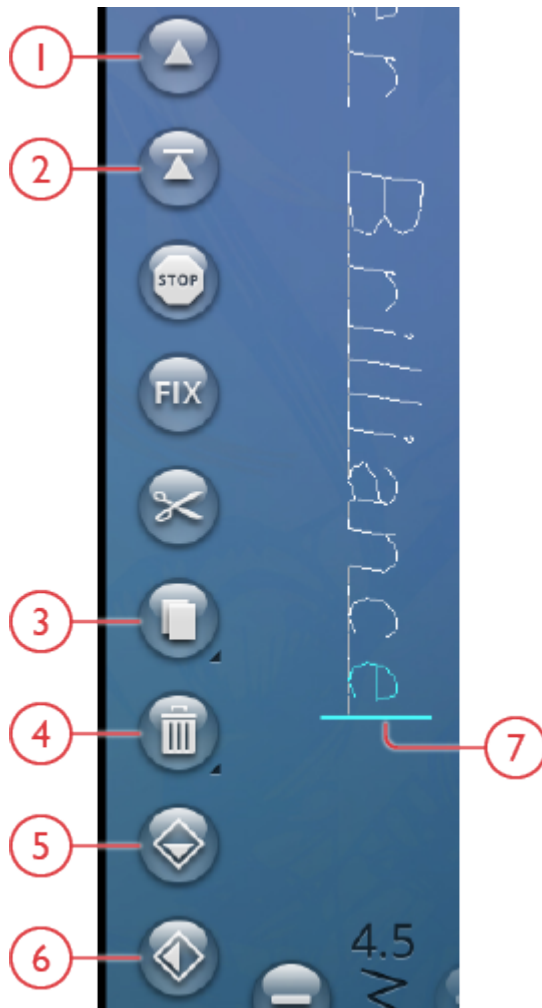

1. Step to previous stitch/go to last
2. Step to next stitch/go to first
3. Duplicate
4. Delete
5. Mirror end to end
6. Mirror side to side
7. Cursor

Adjust the Entire Program

To adjust the entire program, return to sewing mode by touching the OK button. Adjustments made here will affect the entire program. Read about the different stitch settings in sewing mode that will adjust your entire program.



Stitch Program Commands

You can insert FIX, STOP and thread cut commands into the stitch program. These commands will be included in the stitch program and will always be performed when sewing it.

Move the cursor to the position where you want to add a command. Touch the command and an icon will be added into the programmed stitch. This confirms that the command is inserted and it also shows where the command will be performed in the stitch program.

Note: If creating a stitch program in embroidery mode, tie-offs will be added automatically at the beginning and end, allowing you to create a stitch program in between. The commands can be removed.

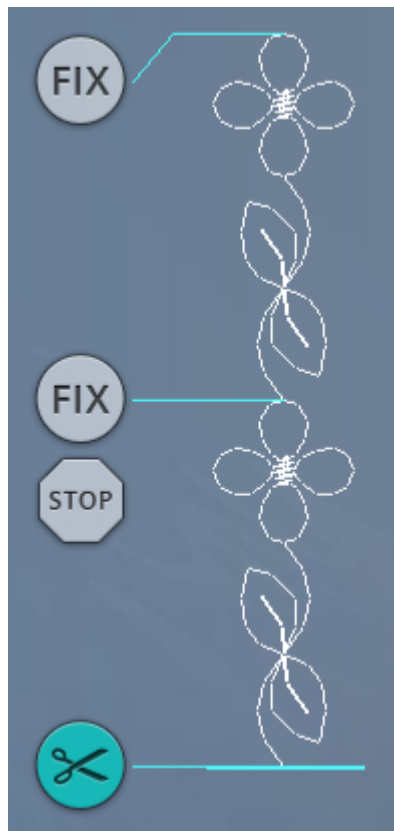

Insert a STOP command by touching the STOP button on the screen. The STOP command will make your machine stop at the selected position in your programmed stitch. This is useful, e.g. if you want to create a stitch program with several rows.



Insert a FIX command by touching the FIX button on the screen. The FIX command will insert a tie-off at the selected position in the program. You can insert the FIX command anywhere in the program.

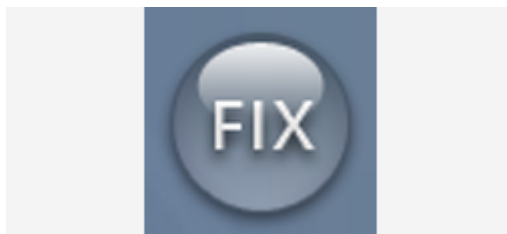

Insert a thread cut command by touching the thread cut button on the screen. Add a thread cut command if you want the machine to tie-off and cut the threads.



Note: If automatic thread cutter is deselected in temporary settings the machine will only fix and stop when it reaches a thread cut command.

Save Program

To save your file, touch the save button and a pop-up will appear on the screen. In the save pop-up you can choose to save the file to the *mySewnet*TM cloud folder or to a USB device. Previously saved designs, stitches, programs and/or fonts are shown. Name your file with the keyboard and touch the OK button.

If you want to save to a folder, simply touch & hold on the folder to open it, then name your file with the keyboard and touch OK in the pop-up to save. To create a new folder, simply touch the create new folder button, name the folder with the keyboard and touch OK. Then touch & hold on the folder to open it and save into the new folder.

Touch the list and thumbnail view button to toggle between showing the files in a list or as thumbnail icons. In list view each file is shown with the file name and file type. In thumbnail view each file is shown with file name and a thumbnail image of the file.

To cancel the save process, close the pop-up window by touching cancel. The save pop-up will close and you will return to program mode.

Learn how to organize your saved files in file manager.



Save button in embroidery edit

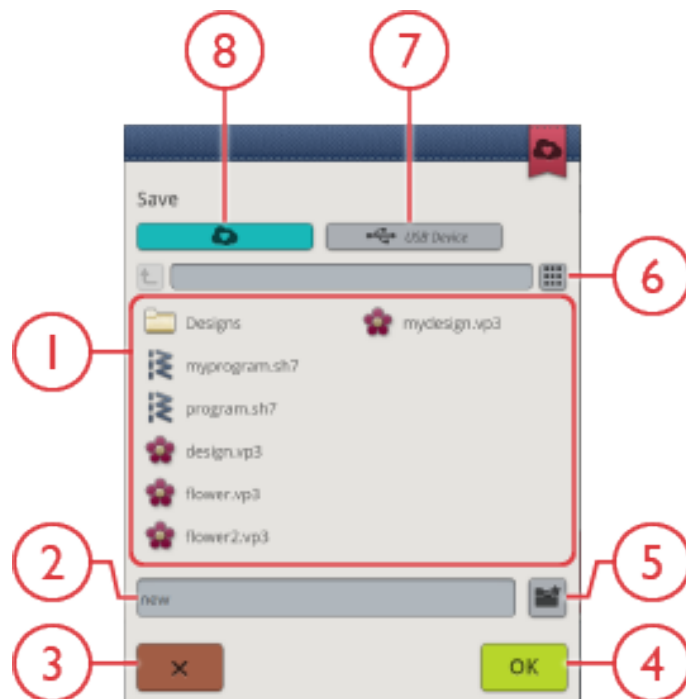

1. Selection area
2. File name
3. Cancel
4. Confirm
5. Create new folder
6. Toggle between list and thumbnail view
7. Save to a USB device
8. Save to the *mySewnet*TM cloud folder

Sew or Embroider Your Stitch Program

To sew your stitch program, load it to sewing mode by touching the OK button in the program window.

If you have opened program in embroidery edit, touching OK in the program window will load your program to embroidery edit.

Note: A program created in embroidery mode will be loaded and saved as a design and can not be sewn as a stitch in sewing mode.



Program Pop-Up Messages

This Stitch Cannot be Programmed

Some stitches are not possible to insert in a stitch program, for example buttonholes and special stitch menus such as 4-way stitches.

The Maximum Number of Stitches Has Been Reached

The stitch you are trying to add will make the stitch program too long. Your stitch program can be up to approximately 500 mm (20") long and contain up to 199 stitches and commands. If the stitch program exceeds the maximum length this pop-up message will appear.

II Settings

Temporary Sewing Settings

Change your temporary sewing settings when you want to change a sewing related setting for your current project. Changes made to temporary sewing settings will be reset at the start of a new JoyOS *advisor*TM project from the JoyOS *advisor*TM feature. When turning the machine off, all changes made in temporary sewing settings will be reset to default.

The following settings can be set in temporary sewing settings:

- *deLuxe*TM stitch system
- Sensor presser foot lift
- Automatic thread cutter
- Automatic FIX
- Stitch limiting options
- Feed teeth options

*deLuxe*TM Stitch System

When the *deLuxe*TM stitch system is selected your machine will automatically choose the best way to control the upper thread, thread portioning or thread tension, based on your selected stitch and settings. Thread portioning automatically and continuously measures the fabric thickness to portion the correct amount of thread for the selected stitch. When using thread tension, the tension discs will keep the correct amount of tension on the upper thread.

For best sewing results we strongly recommend you to keep this setting selected except when using specific special techniques or accessories that do not support thread portioning. Deselect the *deLuxe*TM stitch system in the temporary sewing settings to switch to thread tension.

The control for adjusting thread portioning/thread tension, visible in sewing mode, will change depending on the active stitch and whether the *deLuxe*TM stitch system is selected or not in temporary sewing settings.

Sensor Presser Foot Lift

When selected, the machine automatically raises the presser foot in the following situations:

- When stopping with the needle in the down position the presser foot will automatically raise to pivot height.
- After a cut the presser foot will be raised to lift position.

When deselected, the presser foot will stay lowered.

Automatic Thread Cutter

When selected, the threads are cut automatically in the following situations:

- At cut commands in stitches and programs.
- After sewing a single stitch e.g. a monogram or eyelets.

If deselected, no automatic thread cut will be performed.

Note: Deselect when using optional accessories that are attached in the two holes in the needle plate just above the bobbin cover, to prevent damage to the automatic thread cutter knife located under the needle plate.

Automatic FIX

When selected, the machine will automatically activate the FIX function after a cut has been performed and when a stitch is selected.

Stitch Limiting Options

Set the machine to either stitch width safety or select the size of the twin needle to limit the stitch width and stitch positioning. This will minimize the risk of breaking a needle when sewing with accessories that do not allow the use of the entire stitch width.

Stitch Width Safety

When selected, the machine will only allow a centered straight stitch to prevent damage to the needle, presser foot and needle plate. Select stitch width safety when using an accessory that only supports a centered needle position e.g. straight stitch presser foot. Stitch width safety will automatically be selected when the Straight Stitch Plate is attached to the machine and cannot be deselected as long as the Straight Stitch Plate is attached.

When the Straight Stitch Plate is removed you will be given the option to keep stitch width safety selected or to deselect it. When stitch width safety is activated all twin needle sizes will be disabled as they cannot be used together with stitch width safety.

*Note: The setting are reset at the start of a new project from the JoyOS *advisor*TM feature. Always make sure to remove any accessory that requires this setting or select the setting again after starting a new project.*

Twin Needle

When a twin needle size is selected, the stitch width and stitch position of all stitches are limited according to the selected twin needle size to prevent damage to the needle, presser foot and needle plate. In sewing mode the stitch preview will indicate that a twin needle is selected. When a twin needle size is selected, the stitch width safety will be disabled as it cannot be used together with a twin needle.

*Note: The setting are reset at the start of a new project from the JoyOS *advisor*TM feature. Always make sure to remove any accessory that requires this setting or select the setting again after starting a new project.*

Feed Teeth Options

When auto is selected (recommended) your machine automatically raises or lowers the feed teeth, depending on the stitch and other selected settings. For example, the feed

teeth are lowered when sewing on buttons or when free motion sewing.

Select up and the feed teeth will be raised for all sewing.
Select down and the feed teeth will be lowered for all sewing.

Temporary Embroidery Settings

Change your temporary embroidery settings when you would like to change an embroidery related setting for your current project. Changes made to the temporary embroidery settings will be reset at the start of a new project from the JoyOS *advisor*[™] feature. When turning the machine off, all changes made in temporary embroidery settings will be reset to default.

The following settings can be set in temporary embroidery settings:

- *deLuxe*[™] stitch system
- Embroidery foot type
- Thread cut options

deLuxe[™] Stitch System

When the *deLuxe*[™] stitch system is selected your DESIGNER BRILLIANCE[™] 80 will automatically choose the best way to control the embroidery upper thread based on the design and the selected settings: thread portioning or thread tension. For best embroidery results we strongly recommend that you keep this setting selected and select the spring foot for embroidery foot type.

When the *deLuxe*[™] stitch system is selected thread portioning will be used when the embroidery foot type, spring foot, is selected unless, e.g. the active color block indicates a felting color block or a cutwork needle color block in the color block list.

Thread Cut Options

Choose between three thread cut options: no thread cuts, automatic thread cut and a combination of automatic thread cut and automatic jump stitch trim.

Off

When selected, no automatic thread cuts will be performed by the machine.

Note: Select off when using optional accessories that are attached in the two holes in the needle plate just above the bobbin cover, to prevent damage to the automatic thread cutter knife located under the needle plate.

Note: Regardless of which option is selected the machine will always lower the feed teeth automatically when raising the presser foot to extra lift position.

*Note: The feed teeth options will automatically be reset to auto at the start of a new project from the JoyOS *advisor*[™] feature.*

When the *deLuxe*[™] stitch system is deselected and/or embroidery foot type is set for floating foot, thread tension will be used for all designs and settings.

For some specific special techniques and accessories that cannot be embroidered with thread portioning, the *deLuxe*[™] Stitch System needs to be deselected.

Embroidery Foot Type

Select either the Sensor Q-Foot or floating foot. It is very important that the correct setting is selected for the attached embroidery foot.

For best embroidery results, select and use the Sensor Q-Foot and the *deLuxe*[™] stitch system. This is strongly recommended. Some specific specialty techniques and/or accessories do not support the use of the Sensor Q-Foot, e.g. yarn couching and felting.

When the Sensor Q-Foot is selected the machine will lower the foot to hold the fabric at each stitch. When the floating foot is selected the machine will lower the foot to a pivot height above the fabric. When using a floating foot the presser foot height can be adjusted for improved performance when using different weights of material and/or embroidery threads.

*Note: The embroidery foot type will automatically be reset to Sensor Q-Foot at the start of a new project from the JoyOS *advisor*[™] feature. Make sure you attach the Sensor Q-Foot or change the setting to floating foot (e.g. R-Foot).*

Automatic Thread Cutter

When selected, thread cuts will be automatically performed in the following situations:

- Upper thread is cut automatically and the presser foot raises at color changes.
- Bobbin thread and needle thread are cut and the presser foot raises when an embroidery is finished.

Automatic Jump Stitch Trim

When selected, cuts will be automatically performed and needle thread pulled to the underside of the fabric. This function saves you time trimming after the embroidery is completed. The upper thread will be cut and pulled to the underside of the fabric when starting to embroider after a color change, at the first color block, after stepping stitches and when the machine continues to embroider after a jump stitch.

Thread cuts will be automatically performed in e.g. the following situations:

- Upper thread is cut automatically and the presser foot raises at color changes.
- Bobbin thread and upper thread are cut and the presser foot raises when an embroidery is finished.
- Upper thread is cut automatically at the start of a jump stitch.
- Cut commands in designs, stitches or programs.

Tip: Hold the thread tail when you start embroidering or at a new color block so that you can easily remove the thread end when cut.

Tip: If the front and back of your embroidery will be visible, turn off the automatic jump stitch trim and cut the threads manually.

Tip: If your designs are very close together, e.g. lettering or programmed stitches, turn off the automatic jump stitch trim and cut the thread manually.

Twin Needle Options

When a twin needle size is selected the *deLuxe™* Stitch System will automatically use thread tension. When embroidering with a twin needle the Straight Stitch Plate needs to be removed as it cannot be used together with a twin needle. The twin needle setting will automatically be set when

loading a twin needle embroidery project from the JoyOS *advisor™* project menu.

Note: It is very important to activate the twin needle setting when embroidering with a twin needle to prevent damage to the machine.

Default Sewing Settings

Settings made in the default sewing settings will be saved, even when turning your machine off.

deLuxe™ Stitch System – Default

When selected the *deLuxe™* stitch system will automatically be selected in the temporary sewing settings for all new projects loaded from the JoyOS *advisor™* feature. For more information see the description in the temporary sewing settings.

Sensor Presser Foot Lift – Default

When selected the sensor presser foot lift will automatically be selected in the temporary sewing settings for all new projects loaded from the JoyOS *advisor™* feature. For more information see the description in the temporary sewing settings.

Automatic Thread Cutter – Default

When selected the automatic thread cutter will automatically be selected in the temporary sewing settings for all new projects loaded from the JoyOS *advisor™* feature. For more

information see the description in the temporary sewing settings.

Automatic FIX – Default

When selected the automatic FIX will automatically be selected in the temporary sewing settings for all new projects loaded from the JoyOS *advisor™* feature. For more information see the description in the temporary sewing settings.

Free Motion Options – Default

Choose between two free motion options: free motion floating or free motion spring action. When one of the free motion options is selected the corresponding free motion mode will automatically be selected in sewing mode for all new projects loaded from the JoyOS *advisor™* feature.

It is recommended that you do not set an option for free motion in the default sewing settings; choose an option in sewing mode instead.

For more information see the description in the free motion options in sewing mode

Default Embroidery Settings

All settings made in the default embroidery settings will be saved, even when turning your machine off.

deLuxe[™] Stitch System – Default

When selected the *deLuxe*[™] stitch system will automatically be selected in the temporary embroidery settings for all new projects loaded from the JoyOS *advisor*[™] feature. For more information see the description in the temporary embroidery settings.

Thread Cut Options – Default

When selected the thread cut option will automatically be selected in the temporary embroidery settings for all new projects loaded from the JoyOS *advisor*[™] feature. For more information see the description in the temporary embroidery settings.

Embroidery Pivot Height – Default

If the embroidery pivot height is set in default embroidery settings it will automatically be set to this value in the temporary embroidery settings for all new projects loaded from the JoyOS *advisor*[™] feature. For more information see the description in the temporary embroidery settings.

My Hoops

The selected hoops will be displayed first in the hoop selection list.

When you first load a design, the machine will select the most suitable hoop among the ones you have selected in my hoops.

Note: In the hoop list you will find that some hoop sizes are followed by a letter. These are specialty hoops. For example, E stands for endless hoop, T for texture hoop and M for metal hoop.

Machine Settings

All settings made in the machine settings will be saved, even when turning your machine off.

Language

Select your desired language on the screen. All texts in the machine will be changed.

Audio Volume

Change the audio volume using the slider bar. All sounds in the machine will be affected when the audio volume is changed. When the slider is all the way to the left, the volume is muted.

Audio Repeat

When active, the signal for some warning alerts or attention pop-up messages will be repeated in intervals until the pop-up is closed.

Machine Nickname

Touch to select a nickname for your machine. This can be useful when owning more than one machine, to distinguish one machine from another when working in mySewnet™. The name will be shown on the screensaver.

Lock Screen

If there is the possibility of bumping the screen and changing the stitch or settings while sewing, it is easy to lock the screen.

When selected, the screen is automatically locked whenever it is inactive for ten seconds. A pop-up is shown on the screen and will remain locked until you touch OK in the pop-up.

LED Work Light Brightness

Adjust the brightness of the LED lights to adapt to the light conditions in your sewing room. Simply move the slider to the right to make the LED lights brighter or to the left to make them less bright.

Units

Touch millimeter or inch to set the measurement unit you prefer.

Clock Settings

In clock settings you will find the different settings connected to the clock; select how the clock should be displayed (visible on the top-bar, show a 12- or a -24 hour format) and if you want the clock to be updated automatically or be done manually.

This is also where you set your time zone. The clock is set to UTC (Coordinated Universal Time) standards. For example London is UTC time +/- 0 hours, New York is UTC -5 hours and Sydney is UTC +10 hours. Scroll through the time zones to find the time zone you are in.

Clock Functions

If you have chosen to show the clock in the top-bar, touch the clock to open further clock functions. Here, you can set an alarm, find a stopwatch and see for how long your machine has been sewing since you last reset the timer. Touch the “Reset” button to reset the Stopwatch and/or Sewing time.

Usage

Shows the number of hours sewn and embroidered on the machine since you last reset the timer. You can reset the counter by touching “Reset”.

WiFi Settings

Select the WiFi settings on your machine. In WiFi settings you can activate/deactivate WiFi on your machine, search for available networks and connect. If connected to a network with Internet access the latest firmware update will always be available. When WiFi is connected and you have logged in to the *mySewnet*TM cloud, all your saved files in the machine will synchronize with the *mySewnet*TM cloud.

Read more about the possibilities with WiFi connection in your machine in the WiFi chapter.

*mySewnet*TM Settings

In the *mySewnet*TM settings you can sign in to the *mySewnet*TM cloud or change the user on the machine. You will also be able to create a new user. With a *mySewnet*TM account you will be able to access all of the *mySewnet*TM services.

Read more about the possibilities with *mySewnet*TM in *mySewnet*TM services.

Machine Information

Machine information contains technical machine information such as: machine serial number, machine MAC address and current firmware. In machine information you can clear user account and files.

I2 File Manager

File Manager – Overview

The file manager is used to open design files, font files and stitch files. Store your saved files in the *mySewnet™* cloud

folder or to a USB device connected to your machine. Touch the black arrow on the file manager button to expand the file manager on the screen, touch it again to minimize.

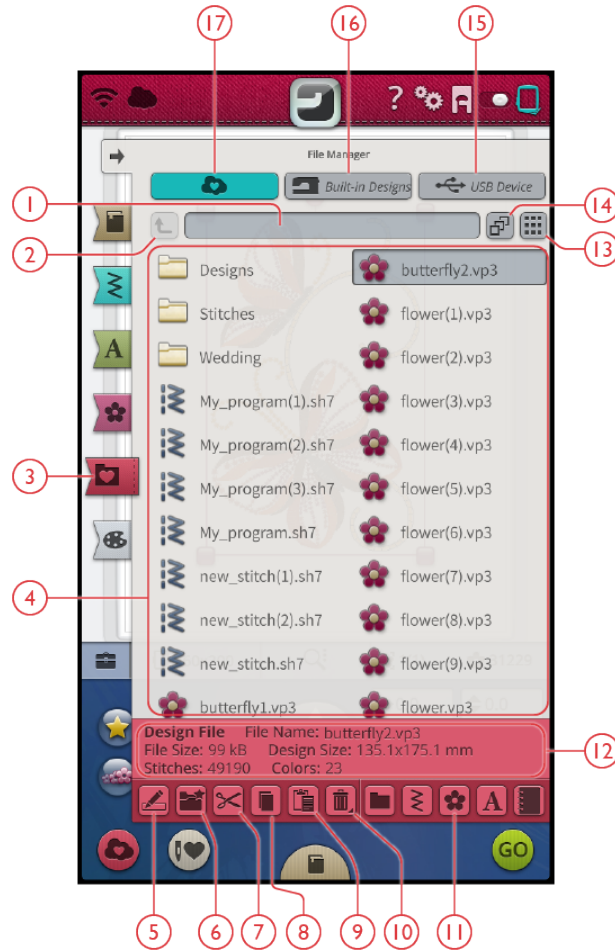

- 1. Current folder
- 2. Move up one folder
- 3. File manager
- 4. Selection area
- 5. Rename file or folder
- 6. Create new folder

- 7. Cut
- 8. Copy
- 9. Paste
- 10. Delete
- 11. Filter files
- 12. File information

- 13. List/thumbnaill view
- 14. Multi-select
- 15. USB device
- 16. Built-in designs
- 17. *mySewnet™* cloud folder

File Formats

Your machine can load the following file formats:

- .VP3, .SHV, .DHV, .VIP, .HUS, .PEC, .PES, .PCS, .XXX, .SEW, .JEF, .EXP, .10* and .DST (embroidery files)
- .SH7 (stitch file)
- .VF3 (embroidery font file)
- .JOS (JoyOS *advisor*TM project files)

Note: Some versions of the embroidery files are not fully supported by your machine.

Browse File Manager

To open file manager, touch the file manager button. Touch the button again to enlarge the file manager on the screen.

Store your designs, fonts and stitches in the *mySewnet*TM cloud folder or to a USB device connected to the USB ports. The USB device button is only available when a USB device is connected to the machine.

To display the content, touch one of the following buttons: *mySewnet*TM cloud folder, built-in designs or USB device. Swipe with your finger from the right to the left to scroll and view the content. Design files and font files are displayed as thumbnail images or with an icon.



File manager button



*mySewnet*TM cloud folder



Built-in designs



USB device



Stitch file icon



Design file icon

Open a File or Folder

Touch a file to read information about the file in the file information area. Touch & hold the file to load it.

If you load an embroidery font file, it will be loaded into program embroidery text. If you load a stitch font file, it will be loaded into program.

Touch & hold on a folder to open it. The content of the folder will be shown in the selection area. The path of an open folder is written in the current folder area.

Multi-Select

If you want to select several designs, stitches or fonts at one time, touch the multi-select button. While multi-select is selected, touch the files you want to use. Copy and paste the selected files e.g. to another folder in file manager.

Note: If trying to load a combination of files/folders that is not possible to load to the same destination a pop-up message will be shown.



Move Up One Folder Level

Use the move up one folder level button to step up through the levels of folders. You can step up all the way to the first level. In the selection area you will see the files and folders for each level as you step up. Touch & hold on a folder to open it.



List/Thumbnail View

Touch the list/thumbnail view button to toggle between showing the files in a list or as thumbnail icons. In list view each file is shown with the file name and file type. In thumbnail view each file is shown with file name and a thumbnail image of the file.



mySewnet™ Cloud Folder

Save designs, stitches and fonts to the *mySewnet™* cloud folder on the machine. If you are signed in to a *mySewnet™* account and connected to *mySewnet™* your saved files will be synchronized automatically with the *mySewnet™* cloud. Read more about the *mySewnet™* cloud in the *mySewnet™* cloud section.



Built-in Designs

Built-in designs contains the designs that are stored in the permanent sewing machine memory. No files can be added to or removed from the built-in designs. You can also access the built-in designs in the design menu.

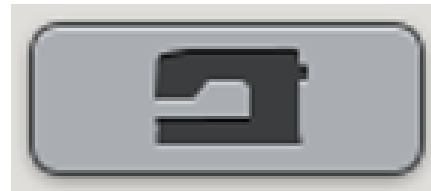

USB Device

The USB device button is only active when a USB device is connected to the machine. Touch the USB device button to display all of the connected devices. Touch a USB device to explore it.



Organize

Below are instructions on how to organize your files in file manager.

Create New Folder

Touch the create new folder button to create a new folder in the current position. A pop-up message opens where you can enter a name for your folder.



Rename a File or Folder

To change the name of a file or folder, touch to select it and then touch the rename file or folder button. A pop-up message opens where you can enter the new name for a file or folder.



Move a File or Folder

Use cut and paste to move file(s) or folder(s) to another location.

Select the file(s) or folder(s) and then touch the cut button. Open the folder where you want to place the selection. Touch the paste button. The file(s) or folder(s) is removed from its original location and now stored in the new folder.

Note: Activate multi-select to be able to select and move more than one file and/or folder the same time.



Cut



Paste

Copy a File or Folder

Use copy and paste to copy file(s) or folder(s) to another location.

Select the file(s) or folder(s), then touch the copy button. Open the folder where you want to place the selection. Touch the paste button. The file(s) or folder(s) is now stored in the new folder and the original file(s) or folder(s) still exists in the previous folder.

Note: Activate multi-select to be able to select and move more than one file and/or folder at the same time.



Copy



Paste

Delete a File or Folder

To delete a file or folder, select it and touch the delete button. A pop-up message will appear so that you can confirm the deletion. If a folder is deleted, all files within the folder are deleted as well.

To delete all files and folders shown in the active folder, touch & hold the delete button for a few seconds. A pop-up message will appear so that you can confirm the deletion of all content.



Toggle Between Edit and Filter View

If you expand file manager on the screen, all buttons used for organizing are shown at the same time in the lower part of file manager.

If file manager is not expanded on the screen, touch the toggle switch to toggle between showing the buttons for editing and buttons for filtering. If a filter button has been selected and the switch is set to edit view, an exclamation mark appears to remind you that files have been filtered and as a result all files in current folder may not be visible on the screen.



Filter Files

If you have a lot of content in a folder you can filter specific files in the current view. Touch one or several of the filter buttons to only show, e.g. designs and/or stitches. The content shown in the selection area will change depending on the selected button(s).

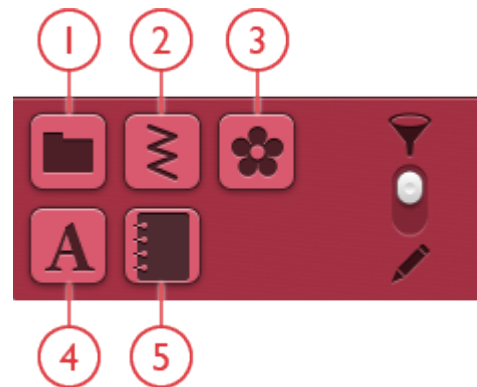

1. Filter folders
2. Filter stitches
3. Filter designs
4. Filter fonts
5. Filter JoyOS *advisor*TM project files

File Manager Pop-up Messages

Do You Want to Delete?

When deleting a file or folder, you will need to confirm the deletion in the pop-up message that appears on screen. This will prevent you from deleting anything by mistake.

Folder Already Exists

You cannot create a new folder with the same name as another folder on the same level. Create your folder on a different level or enter a different name for the folder.

The Available Space in the mySewnet™ cloud is Low

When only a small amount of space is left, your machine will alert you one time. If you continue to fill the space, it will not remind you again, until the space is completely full. Move your files to a USB device by using the cut and paste functions to free up space.

The Combination of Selected File Types Cannot be Loaded

Some file combinations can not be loaded to the same destination using multi-select.

I3 Maintenance

Cleaning the Machine Exterior

To keep your sewing machine operating well, clean it often. No lubrication (oiling) is needed.

Wipe the exterior surface of your machine with a soft cloth to remove any dust or lint built up.

Wipe the screen with a clean, soft and slightly damp microfiber cloth.

Removing the Needle Plate and Cleaning the Bobbin Area

 Lower the feed teeth by touching the presser foot up and extra lift button. Turn off the machine.

- Remove the presser foot and slide off the bobbin cover.
- Place the screwdriver under the needle plate as shown in the picture and gently turn the screwdriver to pop off the needle plate.
- Clean the feed teeth with the brush found with the accessories.

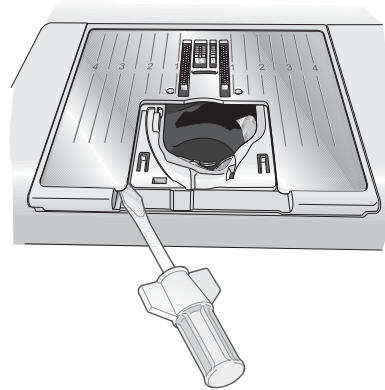

Cleaning Under the Bobbin Area

Clean the area under the bobbin case after sewing several projects or any time you notice an accumulation of lint in the bobbin case area.

- Remove the bobbin case holder (A) covering the front part of the bobbin case by lifting it up.
- Remove the bobbin case (B) by lifting it up.
- Clean with the brush.

 Use caution when cleaning around the automatic thread cutter knife (C).

- Put the bobbin case and the bobbin case holder back in place.

Note: Do not blow air into the bobbin case area. The dust and lint will be blown into your machine.

Note: When using the optional accessory HUSQVARNA VIKING® Embroidery Cutwork Needles or HUSQVARNA VIKING® Felting Embroidery Set, it is necessary to clean the bobbin area after each embroidered design/project.

Note: Regularly clean the lint and threads from the bobbin area. Check the area when changing the needle plate.

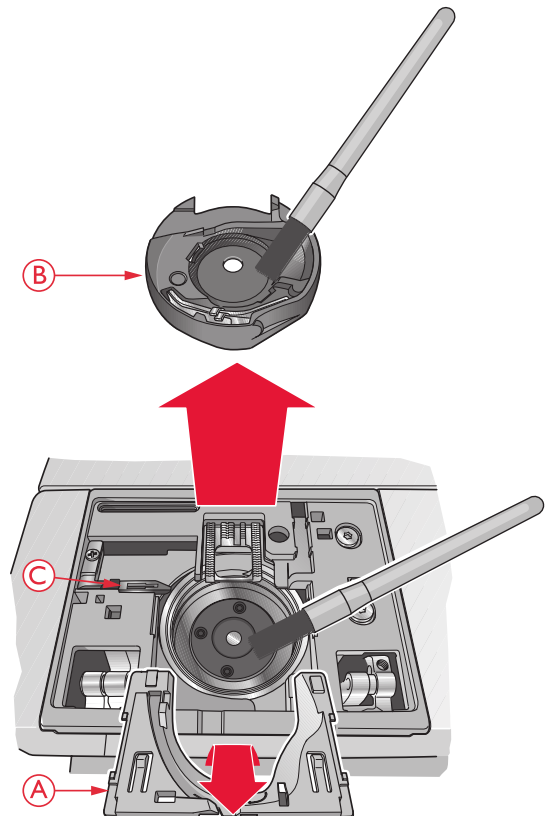

Replacing the Needle Plate

- With feed teeth lowered, place the needle plate so that it fits into the notch at the back (A).
- Press the needle plate down until it clicks into place.
- Slide on bobbin cover.

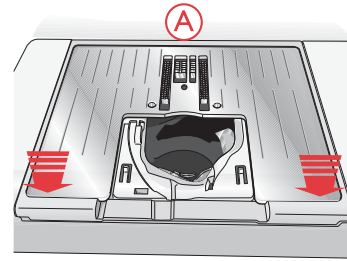

Troubleshooting

In this troubleshooting guide you will find solutions to the problems you may have with your machine. For further information please contact your local authorized

HUSQVARNA VIKING® retailer who will be happy to help you.

General Problems

Bobbin alarm does not work	Clean lint from bobbin area and use only the original HUSQVARNA VIKING® bobbins approved for this model.
Thread cutter does not cut the thread	Remove needle plate and clean lint from bobbin area. Enable automatic thread cutter in the settings menu.
Fabric does not feed	Make sure the machine is not set for free motion sewing. Make sure the feed teeth are not set to down in the settings menu.
Wrong stitch, irregular or narrow stitch	Deactivate twin needle or stitch width safety in the settings menu.
The needle breaks	Insert needle correctly as described, see Changing the Needle, page 31. Use a needle suitable for selected fabric. See Selecting Correct Thread/Needle Combination, page 33.
The machine will not sew	Check that all plugs are securely inserted into the machine and the wall socket.
Poor sewing/embroidery result	Use only accessories designed for your DESIGNER BRILLIANCE™ 80 machine. Follow the on-screen recommendations.
The sewing and embroidery machine screen and/or function buttons do not respond to touch	The sockets and function buttons on the machine can be sensitive to static electricity. If the screen does not respond to touch, turn the machine OFF and then ON again. If the problem persists, contact your authorized HUSQVARNA VIKING® retailer.
When sewing in heavy and/or dense fabrics the machine emits a distinct sound different from the sound normally generated when sewing.	The sound is not an indication of malfunction. The machine is equipped with a pulsating needle piercing feature that helps the needle to penetrate heavy and/or dense fabrics. The sound is caused when the presser foot and fabric lift with the needle. Increase the presser foot pressure to prevent the foot from lifting. If the sound does not seem to be related to the pulsating needle piercing feature, contact your authorized HUSQVARNA VIKING® retailer for service.

The Machine Skips Stitches

Did you insert the needle properly?	Insert needle correctly as described, see Changing the Needle, page 31.
Did you insert a wrong needle?	Use needle system 130/705 H. Use a needle suitable for selected fabric and thread. See Selecting Correct Thread/Needle Combination, page 33.
Is the needle bent or blunt?	Insert a new needle.
Did you thread the machine properly?	Remove the thread completely and rethread the machine, see Horizontal Spool Pin, page 31.
Is the correct presser foot used?	Attach correct presser foot.
Is the needle too small for the thread?	Change the needle.
Is the fabric moving up and down with the needle when free motion sewing or embroidering?	Attach Sensor Q-Foot.

Needle Thread Breaks

Did you insert the needle properly?	Insert needle correctly, see Changing the Needle, page 31.
Did you insert a wrong needle?	Use needle system 130/705 H. Use a needle suitable for selected fabric and thread. See Selecting Correct Thread/Needle Combination, page 33.
Is the needle bent or blunt?	Insert a new needle.
Did you thread the machine properly?	Remove the thread completely and rethread the machine, see Horizontal Spool Pin, page 31.
Is the needle too small for the thread?	Change the needle to the proper size for the thread.
Are you using poor thread with slubs or thread which has become dry?	Change to a new high quality thread purchased from an authorized HUSQVARNA VIKING® retailer.
Is the best spool pin position used?	Try a different spool pin position (vertical or horizontal).
Is the needle plate hole damaged?	Change the needle plate.
Is the thread tension too high for selected thread?	Lower the thread tension in small increments until problem is solved.

Bobbin Thread Breaks

Is the correct bobbin used?	Use only the original bobbins approved for this model.
Did you insert the bobbin properly?	Check the bobbin thread.
Is the needle plate hole damaged?	Change the needle plate.
Is the bobbin area full of lint?	Clean lint from bobbin area and use only the original bobbins approved for this model.
Is the bobbin wound correctly?	Wind a new bobbin.

The Seam Has Uneven Stitches

Is the thread tension correct?	Check needle thread tension. Remove the thread completely and rethread the machine, see Horizontal Spool Pin, page 31.
Is the thread you are using thick or slubbed?	Change the thread.

Is the bobbin thread evenly wound?	Check bobbin winding.
Is a correct needle used?	Insert a proper needle correctly as described, see Changing the Needle, page 31. Use a needle suitable for selected fabric. See Selecting Correct Thread/Needle Combination, page 33.

The Machine Does Not Feed or Feeds Irregularly

Did you thread the machine properly?	Remove the thread completely and rethread the machine, see Horizontal Spool Pin, page 31.
Has sewing lint collected between the feed teeth?	Remove the needle plate and clean the feed teeth with the brush.
Is the free motion setting on?	Turn off free motion setting in sewing mode.
Are the feed teeth set to down?	Make sure the feed teeth are not set to down in the settings menu.
Is the correct presser foot used?	Attach correct presser foot.

Thread Loops are Forming on the Underside of the Embroidery Design

Has the embroidery built up too much to move freely under the presser foot?	Attach Sensor Q-Foot. If using the R-Foot, increase the embroidery pivot height in settings menu in small increments until the problem is solved.
---	--

The Embroidery Design Is Distorted

Is the fabric hooped properly?	The fabric must be tightly hooped. For larger hoops, use hoop clips.
Is the inner embroidery hoop properly inserted into the outer embroidery hoop?	Hoop the fabric in such a way that the inner hoop exactly matches the outer hoop.
Is the area around the embroidery arm and hoop free?	Clear area around the embroidery unit.
Is the hoop attached properly?	Make sure the hoop connector is inserted all the way into the hoop attachment on the embroidery arm.

The Embroidery Design Has Puckered

Did you stabilize your fabric sufficiently?	Ensure you use the proper stabilizer for your technique or fabric type.
---	---

The Machine Will Not Embroider

Is the embroidery unit attached?	Make sure that the embroidery unit is properly attached into the socket.
Is the wrong hoop attached?	Slide on the correct hoop.

Troubleshooting Connectivity

The Machine Cannot Connect to a WiFi Network

The machine will not connect to a WiFi network	Make sure that WiFi is enabled on your machine. Touch the WiFi button on the topbar or go to WiFi settings. Make sure that the machine detects a signal from your WiFi network. If there is no signal, move the machine closer to the WiFi router. Make sure you have selected your WiFi network.
The machine has no Internet connection	Make sure that your WiFi router has access to the Internet.
The WiFi network is password protected	Make sure that you have selected your WiFi network and entered the correct password. If you do not know the password, contact the administrator of your network.

The Machine Cannot Synchronize with the *mySewnet*[™] Cloud

The machine cannot synchronize files with the <i>mySewnet</i> [™] cloud	Make sure that you have a working WiFi connection. Make sure that you have signed in to your <i>mySewnet</i> [™] account. New <i>mySewnet</i> [™] accounts are registered in the machine or at husqvarnaviking.mysewnet.com Make sure that there is available space on the <i>mySewnet</i> [™] cloud. If the <i>mySewnet</i> [™] cloud is not accessible although you have checked the WiFi connection, the server could temporarily be unavailable. Please try again later.
--	---

Service

Have Your Sewing Machine Serviced Regularly by Your Local Authorized Retailer!

If you have followed this troubleshooting information and still have problems, contact your retailer. It may be helpful to bring the fabric, thread and stabilizer you are using with you. If you have a stitch out that shows the problem, please bring that as well. A sewing sample will often give better information than words and help your technician diagnose the problem.

Non-Original Parts and Accessories

The warranty does not cover any defect or damage caused by use of non-original accessories or parts.

Technical specification

DESIGNER BRILLIANCE[™] 80 machine

Rated voltage	100–120V/200–240V, 50–60Hz
Nominal consumption	<100W
Light	LED lamps
Sewing speed	1050 stitches/minute maximum

Foot control model	FR5
Safety class	II
WiFi module:	
Frequency	2.4GHz band 802.11 b/g/n
Transmitting power	+17 dBm
Receiver sensitivity	-97 dBm
Net weight (kg), machine only	10
Net weight (kg), embroidery unit	3.7
Machine dimensions:	
Length (mm)	485
Width (mm)	240
Height (mm)	300

- The technical specifications and this owner's manual can be changed without prior notice.

14 IMPORTANT

IMPORTANT SAFETY INSTRUCTIONS

This household sewing machine is designed to comply with IEC/EN 60335-2-28 and UL1594.

When using an electrical appliance, basic safety precautions should always be followed, including the following:

Read all instructions before using this household sewing machine. Keep the instructions at a suitable place close to the machine. Make sure to hand them over if the machine is given to a third party.

DANGER –TO REDUCE THE RISK OF ELECTRIC SHOCK:

- A sewing machine should never be left unattended when plugged in. Always unplug this sewing machine from the electric outlet immediately after using and before cleaning, removing covers, lubricating or when making any other user servicing adjustments mentioned in the instruction manual.

WARNING –TO REDUCE THE RISK OF BURNS, FIRE, ELECTRIC SHOCK, OR INJURY TO PERSON:

- Do not allow to be used as a toy. Close attention is necessary when this sewing machine is used by or near children.
- Use this sewing machine only for its intended use as described in this manual. Use only attachments recommended by the manufacturer as contained in this manual.
- Never operate this sewing machine if it has a damaged cord or plug, if it is not working properly, if it has been dropped or damaged, or dropped into water. Return the sewing machine to the nearest authorized dealer or service center for examination, repair, electrical or mechanical adjustment.
- Never operate the sewing machine with any air openings blocked. Keep ventilation openings of the sewing machine and foot control free from the accumulation of lint, dust, and loose cloth.
- Keep fingers away from all moving parts. Special care is required around the sewing machine needle.
- Always use the proper needle plate. The wrong plate can cause the needle to break.
- Do not use bent needles.
- Do not pull or push fabric while stitching. It may deflect the needle causing it to break.

- Wear safety glasses.
- Switch the sewing machine off (“0”) when making any adjustment in the needle area, such as threading needle, changing needle, threading bobbin, or changing presser foot, etc.
- Never drop or insert any object into any opening.
- Do not use outdoors.
- Do not operate where aerosol (spray) products are being used or where oxygen is being administered.
- To disconnect, turn all controls to the off (“0”) position, then remove plug from outlet.
- Do not unplug by pulling on cord. To unplug, grasp the plug, not the cord.
- The foot control is used to operate the machine. Avoid placing other objects on the foot control.
- Do not use the machine if it is wet.
- If the LED lamp is damaged or broken, it must be replaced by the manufacturer or its service agent or a similarly qualified person, in order to avoid a hazard.
- If the supply cord connected with the foot control is damaged, it must be replaced by the manufacturer or its service agent or a similarly qualified person, in order to avoid a hazard.
- This sewing machine is provided with double insulation. Use only identical replacement parts. See instructions for Servicing of Double-Insulated Appliances.

SAVE THESE INSTRUCTIONS

FOR EUROPE ONLY:

This appliance can be used by children aged from 8 years and above and persons with reduced physical, sensory or mental capabilities or lack of experience and knowledge if they have been given supervision or instruction concerning use of the appliance in a safe way and understand the hazards involved. Children shall not play with the appliance. Cleaning and user maintenance shall not be made by children without supervision.

The noise level under normal operating conditions is less than 80dB(A).

The machine must only be used with foot control of type FR5 manufactured by Shanghai Binao Precision Mould Co., Ltd.

FOR OUTSIDE EUROPE:

This sewing machine is not intended for use by persons (including children) with reduced physical, sensory or mental capabilities, or lack of experience and knowledge, unless they have been given supervision or instruction concerning use of the sewing machine by a person responsible for their safety.

Children should be supervised to ensure that they do not play with the sewing machine.

The noise level under normal operating conditions is less than 80dB(A).

The machine must only be used with foot control of type FR5 manufactured by Shanghai Binao Precision Mould Co., Ltd.

SERVICING OF DOUBLE INSULATED PRODUCTS

In a double-insulated product, two systems of insulation are provided instead of grounding. No ground means is provided

on a double-insulated product, nor should a means for grounding be added to the product. Servicing of a double-insulated product requires extreme care and knowledge of the system and should be done only by qualified service personnel. Replacement parts for a double-insulated product must be identical to those parts in the product. A double-insulated product is marked with the words 'DOUBLE INSULATION' or 'DOUBLE INSULATED'.

Licenses

Placeholder for links to licence documents.

You have purchased a modern, updatable sewing and embroidery machine. As we regularly release firmware updates, it is possible that there may be some differences between the machine firmware and the firmware described in the user's guide. Consult your local authorized HUSQVARNA VIKING® retailer, and be sure to visit our website at www.husqvarnaviking.com for the latest updates of the firmware and the user's guide.

We reserve the right to change the machine equipment and the assortment of accessories without prior notice, or make modifications to the performance or design. Such modifications, however, will always be to the benefit of the user and the product.

INTELLECTUAL PROPERTY

Patents protecting this product are listed on a label positioned underneath the Sewing Machine.

DESIGNER BRILLIANCE, EXCLUSIVE SENSOR SYSTEM, MYSEWNET, VIKING, and KEEPING THE WORLD SEWING & Design are trademarks of Singer Sourcing Limited LLC.

HUSQVARNA and the "H" Crown Device are trademarks of Husqvarna AB. © 2018 Singer Sourcing Limited LLC. All rights reserved.



Please note that on disposal, this product must be safely recycled in accordance with relevant National legislation relating to electrical/electronic products. Do not dispose of electrical appliances as unsorted municipal waste, use separate collection facilities. Contact your local government for information regarding the collection systems available. When replacing old appliances with new ones, the retailer may be legally obligated to take back your old appliance for disposal free of charge.

If electrical appliances are disposed of in landfills or dumps, hazardous substances can leak into the groundwater and get into the food chain, damaging your health and well-being.

Manufacturer

VSM GROUP AB

Drottninggatan 2, SE-56184, Huskvarna, SWEDEN



www.husqvarnaviking.com